

eclipse3[™]
WITH
autoSAT[™]

Eclipse 3[™] with autoSAT[®]

Personal Ambulatory Oxygen System (PAOS)[™]

Model 1000B



PROVIDER TECHNICAL MANUAL



CAIRE[®]
SEQUAL[®]

TABLE OF CONTENTS

General Information 4

Warning and Caution Statements 4

Introduction to the Eclipse 3 Oxygen System 5

Eclipse Oxygen System Specifications 6

Pulse Dose Mode Specifications 7

Power Accessory Specifications 7

AC Power Supply 7

DC Power Supply 7

Power Cartridge (Battery) 7

Independent Safety Testing 8

Provider Support Policy 8

Electromagnetic Compatibility 9

Guidance and Manufacturer's Declarations 9

How The Eclipse 3 Works 13

Introduction 13

ATF® Concentrator Module 13

Compressor and Compressor Enclosure 14

Power Distribution 14

Control Board 14

Control Panel 15

User Controls & System Status Indicators 15

Continuous Flow Mode 17

Pulse Dose Mode 17

Provider Mode Functions 18

Alarm Code 18

Pulse Mode Sensitivity Adjustment 18

Hours of Operation 18

9V Battery Status 18

Rise Time 18

Software Version 18

Service Mode Functions 19

EDAT 19

Power Supplies 20

AC Power Supply 20

DC Power Supply 20

Power Cartridge 21

Typical New Power Cartridge Operation Time 21

Charging Algorithm 24

Training The Patient 25

Introduction 25

Pre-Delivery Check List 25

Indications for Use 26

Contraindications 26

Basic Concept Training 26

Safety Guidelines and Operational Safety

Warnings/Cautions 26

Locating the Eclipse 27

The Users Manual 27

Showing Panel Buttons, Indicators, Alerts

and Alarms 27

Showing Power Cartridge Power Level 28

Selecting the Proper Flow Mode and Setting 28

Selecting Continuous Flow Mode 28

Selecting Pulse Dose Mode 28

Battery Conservation Feature 29

Adjusting the Pulse Mode Sensitivity Setting 29

Adjusting Rise Time 30

Connecting the AC Power Supply 30

Connecting the DC Power Supply 31

Active Lifestyle Training 31

Attach the Universal Cart 32

Using Around the House 29

Traveling by Vehicle 29

Traveling by Air 34

Traveling by Cruise Ship 34

Traveling by Train 34

Eclipse Maintenance 34

Weekly Maintenance—Patient 34

Clean the Air Inlet Filter 35

Clean and Care for the Tubing and Cannula 35

Clean the Cabinet and Control Panel

and Power Supplies 35

Monthly Maintenance—Patient 36

Care for the Power Cartridge 36

Calibrating the Power Cartridge 36

Patient Training Checklist 37

TABLE OF CONTENTS (CONTINUED)

Annual Maintenance—Provider38

Introduction	38
Annual Maintenance Check List.....	38
Checking and Replacing the Power Cartridge.....	38
Eclipse Monthly Run Cycle.....	38
Annual Maintenance Procedures	39
Removing the Unit Cover.....	39
Remove and Replace 9 Volt Battery.....	43
Remove and Replace HEPA Filter.....	44
External Filters (E1, E2, E2 PLus, and Early E3s)....	44
Internal Filters (Newer E3s).....	45
Remove and Replace the Compressor	
Intake Filter.....	47
Reinstalling or Replacing the Unit Cover.....	48
Test Procedures.....	49
Eclipse Purity and Flow Rate Test	
Procedure - Preferred Method	49
Purity and Flow Rate Test Procedure-	
Alternate Method.....	51
Assembly and Alarm Verification Tests.....	51
Record Hours of Operation & Software Version.....	52
Electrical Safety Test.....	53
Cleaning the Eclipse	53
Provider Service and Maintenance Record.....	54
Shipping and Transporting the Eclipse.....	55
Storing the Eclipse	55
Discarding	55

Troubleshooting, Service, and

Repair Procedures56

System Troubleshooting and Alarms	57
Alarm Conditions and Alarm Codes	60
Malfunction Codes.....	61
System Schematics and Diagrams.....	62
Oxygen Circuit.....	65
Remove and Replace the ATF Module.....	65

Remove and Replace the Product Tank	
Assembly (PN 6138-SEQ) Eclipse 1,	
Eclipse 2, Early Eclipse 3	68
Routing Diagram for Pneumatic Tubing	70
Remove and Replace the Product Tank	
Assembly (PN 4378-SEQ) Eclipse 3–2011 in	
SN 11f06100456 and Above.....	71
Electronics.....	76
Remove and Replace the Control	
Board Assembly	76
Remove and Replace the Buzzer Wire Harness.....	78
Control Board Connector Diagram	79
Remove and Replace the Power Manager	
Printed Circuit Board	80
Power Manager PC Board Connector Diagram.....	83
Power Manager PCB Identification.....	84
Compressor	89
Remove and Replace the Compressor Box.....	89
Preventative Maintenance Parts.....	93
Replacement Parts List	93
Optional Accessories	94

Chart-SeQual Customer Service Contact

Information.....95



GENERAL INFORMATION

This technical manual will familiarize you with Provider-specific information regarding the Eclipse 3 Oxygen System. Instructions in this manual are intended to help ensure that:

- Providers are familiar with Eclipse 3 system components and system principles of operation
- Providers are given proper guidance in the use of the Eclipse 3 and its accessories that can be conveyed to patients
- Providers are made aware of the care, diagnostics, maintenance, and repair of the Eclipse 3

Warning and Caution Statements

Safety instructions are defined as follows:

WARNING:		Important safety information for hazards that might cause serious injury.
CAUTION		Important information for preventing damage to the Eclipse.
NOTE:		Places emphasis on an operating characteristic or important consideration.

INTRODUCTION TO THE ECLIPSE 3 OXYGEN SYSTEM

ECLIPSE 3



UNIVERSAL CART



PN: 5991-SEQ



AC POWER SUPPLY WITH NEMA POWER CORD



PN: 5941-SEQ

DC POWER SUPPLY



PN: 5942-SEQ

POWER CARTRIDGE (BATTERY)



PN: 7082-SEQ



Oxygen Concentrator

Dimensions (H x W X D)	19.3 x 12.3 x 7.1 inches (49.0cm x 31.2cm x 18.0cm)
Weight Eclipse Power Cartridge	15.0 pounds 3.4 pounds
Flow Settings Continuous Flow (measured in Liters Per Minute LPM) Pulse Dose (measured in mL)	0.5 to 3.0 LPM (0.5 liter increments) 16-96 (16mL increments), 128mL, 160mL, 192mL
Continuous Flow Accuracy	+/- 10% or 200ml/min, whichever is greater
Oxygen Concentration	87-95.6% for all flow settings
Maximum System Pressure	15 psig (103.5 kPa)
Oxygen Output Pressure	5.0 psig (34.5 kPa) nominal
Oxygen Concentration Status Indicator	Green Light = Normal Operation Yellow Light = Warning or Caution, less than 85% ± 3% Red Light Flashing = Abnormal Operation, less than 70% ± 5%
Nominal Sound Level 3.0 LPM Continuous Flow 3.0 Pulse Dose Mode	48 dB(A) 40 dB(A)
Operating Environment Temperature Humidity	50° F to 104° F (+10° to 40°C) 10% to 95%, Non-condensing, 82.4°F (28°C) Maximum Dew point
Storage Environment Temperature Humidity	-4° F to 140° F (-20° to 60°C) Up to 95% Non-condensing
Altitude	0 – 13,123 feet (0 - 4,000 meters)
Nominal Power 0.5 LPM Continuous flow 3 LPM Continuous Flow 1.0 Pulse Dose Setting 6.0 Pulse Dose Setting Battery Charging	48 Watts 145 Watts 45 Watts 95 Watts 50 Watts
Nominal Power Cartridge operating time Continuous Flow 2.0 LPM 3.0 LPM Pulse Dose (@ 12 BPM) 2.0 6.0	2.0 hours 1.3 hours 5.2 hours 3.5 hours Note: Times will <u>decrease</u> with higher bolus size, breath rate, ambient temperature, power cartridge age and use over time.
Continuous Flow Indication	Expressed in liters per minute (LPM)
Audible Alarm Indicators	<ul style="list-style-type: none"> • Loss of Power/Hot Power Cartridge • Low Power Cartridge/Warm Power Cartridge • Low Oxygen Output • O₂ Flow Outside Normal Limits • Unit Malfunction • Low 9V battery
Back-Up Alarm Power	9V Internal Battery
Filters	Air Inlet, HEPA, Compressor Intake
Device Classification	IEC Class I, Type B Applied Part, IPX0

Pulse Dose Mode Specifications

Pulse Settings	1.0 to 6.0, in 16mL increments and 128mL, 160mL, 192mL
Trigger Sensitivity	Adjustable between settings of 1 (most sensitive) to 3 (least sensitive)
Adjustable Bolus Rise Time	Adjustable settings of Fast(factory setting), Medium, or Slow
Trigger Criteria	<ul style="list-style-type: none"> Cannula pressure has dropped below the trigger point (typically between 0.15– 0.45 cm of H₂O of negative pressure) At least 1¼ seconds has passed since the last pulse began
Minimum time between breaths	1.25 seconds (max. 3 consecutive breaths)
Response to Missing Breaths	While in Pulse Dose Mode, the Eclipse 3 is always monitoring for breath detection. After 15 seconds of no breath detected, the Eclipse 3 “delivers” Continuous Flow at the last Continuous Flow setting. After another 15 seconds, the Eclipse 3 stops delivering Continuous Flow and waits 15 seconds for a breath. The Eclipse 3 will stay in this modality until a breath is detected. (See Power Cartridge Conservation Feature, page 26.)

BOLUS VOLUME (+/- 15%)	Pulse Dose Setting	Bolus Size (± 15%) mL	AC Power Supply and Power Cartridge (Battery)	DC Power Supply
			Max Breath Rate	Max Breath Rate
	1.0	16	40	40
	2.0	32	40	40
	3.0	48	40	40
	4.0	64	40	31
	5.0	80	37	25
	6.0	96	31	20
	-	128	23	15
	-	160	18	12
	-	192	15	10

NOTE: Bolus volume decreases as breath rate exceeds published range.

Power Accessory Specifications

AC Power Supply

Input Voltage	100-240VAC, 50-60 Hz
Input Power	245-260 VA
Output Voltage	28 VDC
Output Power	200W

DC Power Supply

Input Voltage	11.5-18VDC
Output Voltage	26 VDC
Output Power	150W Max

Power Cartridge (Battery)

Output voltage	14.8 VDC
Capacity	Quantity (2) 97.5 W-hrs batteries (Each containing 7.92 grams equivalent Lithium content)
Nominal Power Cartridge Life	80% Capacity after 500 Charge/Discharge cycles
Power Cartridge Recharge Time	1.8 to 5.0 hours, dependent on flow setting, to achieve 80% capacity from a fully discharged Power Cartridge

Independent Safety Testing

Eclipse System and Eclipse Concentrator, Model 1000B	
Safety	IEC 60601-1 :1988 + A1 :1991 + A2 :1995 + Corrigendum (6/95) EN 60601-1(1990) + A1(1993) + A2(1995) + A12(1993) + A13(1996) + Corrigenda (7/94)
Electromagnetic Compatibility	FCC 15B (Sec. 107 & 109), EN55011, EN60601-1-2 :2001, EN6100-3-2, EN61000-3-3, IEC61000-4-2, IEC61000-4-3, IEC61000-4-4, IEC61000-4-5, IEC61000-4-6, IEC61000-4-8, IEC61000-4-11, IEC 60601-1-2 :2001, RTCA DO 160 Rev E
AC Power Supply, Model 5941	
Safety	IEC 60601-1:1988 + A1:1991 + A2:1995
Electromagnetic Compatibility	FCC 15B (Sec. 107 & 109), EN55011, EN60601-1-2 :2001, EN6100-3-2, EN61000-3-3, IEC61000-4-2, IEC61000-4-3, IEC61000-4-4, IEC61000-4-5, IEC61000-4-6, IEC61000-4-8, IEC61000-4-11, EN55014-1
DC Power Supply, Model 5942	
Safety	Portions of IEC 60601-1:1988 + A1:1991 + A2:1995
Electromagnetic Compatibility	FCC 15B (Sec. 109), EN55011, EN60601-1-2 :2001, IEC61000-4-2, IEC61000-4-3, IEC61000-4-4, IEC61000-4-6, IEC 60601-1-2 :2001
Power Cartridge 2400, PN 7082	
Safety	IEC 62133, UL60950-1, First Edition (UL File MH29443), IEC 60601-1:1988 + A1:1991 + A2:1995, UN Transportation Tests T1-T8
Electromagnetic Compatibility	EN 61000-6-3 :2001 (EN55022 :1998+A1 :2001+A2 :2003), EN61000-6-1 :2001, EN61000-4-2 :1995+A1 :1998, EN61000-4-3 :2002
Any CSA-CUS mark for the Eclipse system does not encompass operation with the DC Power Supply Model 5942.	

PROVIDER SUPPORT POLICY

Objective: As a manufacturer our organizational goal is to provide customer support and assistance to the highest level of excellence.

Customers are Providers (which include Dealers, Distributors and Agents).

Support includes, but is not limited to, troubleshooting and Return Material Authorizations (RMA).

Business Hours are Monday – Friday, 8:00am – 6:00pm EST.

Chart-SeQual can only support customers who are recognized as Providers, Dealers, Distributors and/or Agents. These partnerships are qualified as having an existing account or are in the process of credit application completion. All patient or end-user inquiries including but not limited to RMA, warranty or serial number questions must be handled by their Provider.

Provider Support Policy: Chart-SeQual Technologies is unable to provide direct assistance, clinical advice or recommendations to a patient or end-user. Providers have sole responsibility in assisting their patients.

ELECTROMAGNETIC COMPATIBILITY

This equipment has been tested and found to comply with the limits for medical devices to the IEC60601-1-2 Electromagnetic Compatibility standard. These limits are designed to provide reasonable protection against harmful interference in a typical medical installation. This equipment generates, uses, and can radiate radio frequency energy and, if not installed according to the instructions, may cause harmful interference to other devices in the vicinity. There is, however no guarantee that interference will not occur in a particular installation. If this equipment does cause harmful interference to other devices, which can be determined by turning the equipment off and on, the User is encouraged to try to correct the interference by one or more of the following measures:

- Reorient or relocate the receiving device.
- Increase the separation distance between the equipment.
- Connect the equipment into an outlet on a circuit different from that which the other device(s) are connected.
- Consult with Chart SeQual’s Technical Support Department for help.

Medical Electrical Equipment needs special precautions regarding EMC and needs to be installed and put into service according to the EMC information provided in this manual.

Portable and mobile RF communications equipment can affect Medical Electrical Equipment.

The use of Accessories, transducers, and cables other than those specified, with the exception of transducers and cables sold by the Manufacturer of this device as replacement parts for internal components, may result in increased Emissions or decreased Immunity of the Eclipse 3.

The Eclipse 3 should not be used adjacent to or stacked with other equipment and that if adjacent or stacked use is necessary, the Eclipse 3 should be observed to verify normal operation in the configuration in which it will be used.

Guidance and Manufacturer’s Declaration - electromagnetic emissions		
The Eclipse 3 is intended for use in the electromagnetic environment specified below. The customer or the user of the Eclipse 3 should assure that it is used in such an environment.		
Emissions Test	Compliance	Electromagnetic environment - guidance
RF emissions EN 55011	Group 1	The Eclipse 3 uses RF energy only for its internal function. Therefore, its RF emissions are very low and are not likely to cause any interference in nearby electronic equipment.
RF emissions EN 55011	Class B	The Eclipse 3 is suitable for use in all establishments, including domestic establishments and those directly connected to the public low - voltage power supply network that supplies buildings used for domestic purposes.
Harmonic emissions IEC 61000-3-2	Class A	
Voltage fluctuations/ flicker emissions IEC 61000-3-3	Complies	

Guidance and manufacturer's declaration–electromagnetic immunity

The Eclipse 3 is intended for use in the electromagnetic environment specified below. The customer or the user of the Eclipse 3 should assure that it is used in such an environment.

Immunity test	IEC 60601 test level	Compliance level	Electromagnetic environment – guidance
Electromagnetic environment – guidance IEC 61000-4-2	±6 kV contact ±8 kV air	±6 kV contact ±8 kV air	Floors should be wood, concrete or ceramic tile. If floors are covered with synthetic material, the relative humidity should be at least 30 %.
Electrical fast transient/burst IEC 61000-4-4	±2 kV for power supply lines ±1 kV for input/output lines	±2 kV for power supply lines N/A	Mains power quality should be that of a typical commercial or hospital environment.
Surge IEC 61000-4-5	±1 kV line(s) to line(s) ±2 kV line(s) to earth	±1 kV line(s) to line(s) ±2 kV line(s) to earth	Mains power quality should be that of a typical commercial or hospital environment.
Voltage dips, short interruptions and voltage variations on power supply input lines IEC 61000-4-11	<5 % U_T (>95 % dip in U_T) for 0,5 cycle 40 % U_T (60 % dip in U_T) for 5 cycles 70 % U_T (30 % dip in U_T) for 25 cycles <5 % U_T (>95 % dip in U_T) for 5 sec	<5 % U_T (>95 % dip in U_T) for 0,5 cycle 40 % U_T (60 % dip in U_T) for 5 cycles 70 % U_T (30 % dip in U_T) for 25 cycles <5 % U_T (>95 % dip in U_T) for 5 sec	Mains power quality should be that of a typical commercial or hospital environment. If the user of the Eclipse 3 requires continued operation during power mains interruptions, it is recommended that the Eclipse 3 be powered from an uninterruptible power supply or a battery.
Power frequency (50/60 Hz) magnetic field IEC 61000-4-8	3 A / m	3 A / m	Power frequency magnetic fields should be at levels characteristic of a typical location in a typical commercial or hospital environment.

NOTE U_T is the a.c. mains voltage prior to application of the test level.

Guidance and manufacturer’s declaration–electromagnetic immunity

The Eclipse 3 is intended for use in the electromagnetic environment specified below. The customer or the user of the Eclipse 3 should assure that it is used in such an environment.

Immunity test	IEC 60601 test level	Compliance level	Electromagnetic environment – guidance
Conducted RF IEC 61000-4-6	3 Vrms 150 kHz to 80 MHz	3 Vrms	Portable and mobile RF communications equipment should be used no closer to any part of the Eclipse 3, including cables, than the recommended separation distance calculated from the equation applicable to the frequency of the transmitter. Recommended separation distance $d = 1.2\sqrt{P}$ $d = 1.2\sqrt{P}$ 80 MHz to 800 MHz $d = 2.3\sqrt{P}$ 800 MHz to 2,5 GHz where P is the maximum output power rating of the transmitter in watts (W) according to the transmitter manufacturer and d is the recommended separation distance in metres (m). Field strengths from fixed RF transmitters, as determined by an electromagnetic site survey, ^a should be less than the compliance level in each frequency range. ^b Interference may occur in the vicinity of equipment marked with the following symbol: 
Radiated RF IEC 61000-4-3	3 V/m 80 MHz to 2,5 GHz	3 V/m	

NOTE 1 At 80 MHz and 800 MHz, the higher frequency range applies.

NOTE 2 These guidelines may not apply in all situations. Electromagnetic propagation is affected by absorption and reflection from structures, objects and people.

^a Field strengths from fixed transmitters, such as base stations for radio (cellular/cordless) telephones and land mobile radios, amateur radio, AM and FM radio broadcast and TV broadcast cannot be predicted theoretically with accuracy. To assess the electromagnetic environment due to fixed RF transmitters, an electromagnetic site survey should be considered. If the measured field strength in the location in which the Eclipse 3 is used exceeds the applicable RF compliance level above, the Eclipse 3 should be observed to verify normal operation. If abnormal performance is observed, additional measures may be necessary, such as re-orienting or relocating the Eclipse 3.

^b Over the frequency range 150 kHz to 80 MHz, field strengths should be less than 3 V/m.

**Recommended separation distances
between portable and mobile RF communications equipment and the Eclipse 3**

The Eclipse 3 is intended for use in an electromagnetic environment in which radiated RF disturbances are controlled. The customer or the user of the Eclipse 3 can help prevent electromagnetic interference by maintaining a minimum distance between portable and mobile RF communications equipment (transmitters) and the Eclipse 3 as recommended below, according to the maximum output power of the communications equipment.

Rated maximum output power of transmitter W	Separation distance according to frequency of transmitter m		
	150 kHz to 80 MHz $d = 1.2\sqrt{P}$	80 MHz to 800 MHz $d = 1.2\sqrt{P}$	800 MHz to 2,5 GHz $d = 2.3\sqrt{P}$
0,01	0.12	0.12	0.23
0,1	0.38	0.38	0.73
1	1.2	1.2	2.3
10	3.8	3.8	7.3
100	12	12	23

For transmitters rated at a maximum output power not listed above, the recommended separation distance d in metres (m) can be estimated using the equation applicable to the frequency of the transmitter, where P is the maximum output power rating of the transmitter in watts (W) according to the transmitter manufacturer.

NOTE 1 At 80 MHz and 800 MHz, the separation distance for the higher frequency range applies.

NOTE 2 These guidelines may not apply in all situations. Electromagnetic propagation is affected by absorption and reflection from structures, objects and people.

How The Eclipse 3 Works

INTRODUCTION

The Eclipse 3, Personal Ambulatory Oxygen System with autoSAT Technology is a portable medical device used to extract oxygen from the atmosphere, concentrate it to 87–95.6% and present the oxygen to the patient. The device will operate in Continuous Flow Mode or Pulse Dose Mode. In Continuous Flow Mode the oxygen is provided at a constant flow rate between 0.5 and 3.0 LPM. In Pulse Dose Mode, oxygen is supplied in a bolus at the beginning of each inspiration, providing a selectable range setting of 16mL to 192mL.

The Eclipse operates from either external power or from an internal rechargeable Power Cartridge. The system includes a “Smart Battery” charger that recharges the internal Power Cartridge whenever the Eclipse is connected to AC power. The system monitors and controls both the power source and the Power Cartridge charger.

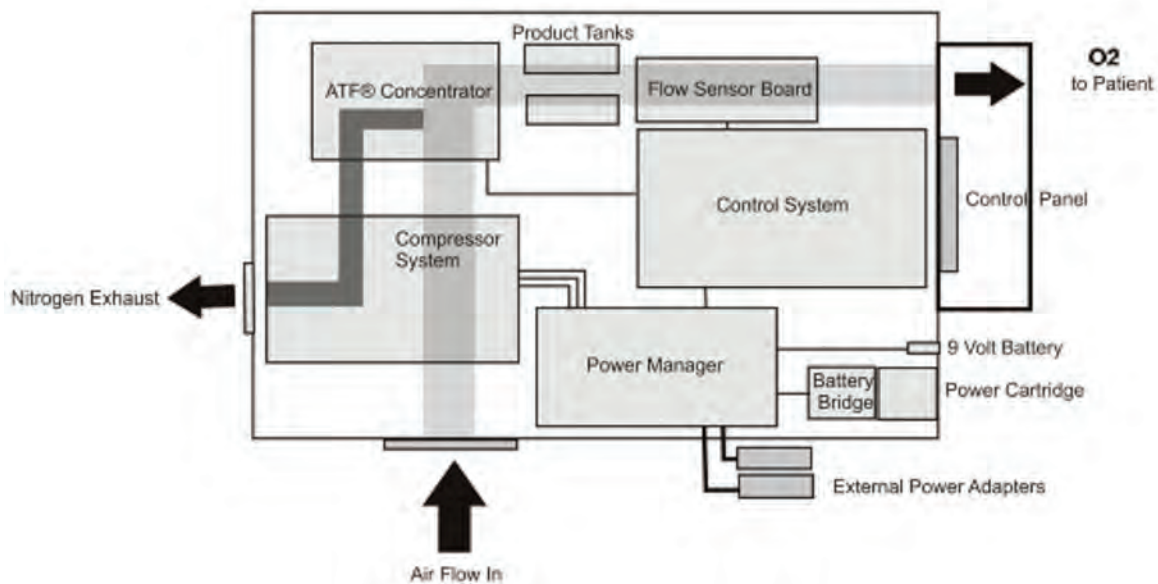

Figure 1: ECLIPSE System Block Diagram

ATF® CONCENTRATOR MODULE

The Eclipse uses a passive system to separate oxygen from air. Air flows into the Eclipse where it is filtered and then enters the compressor. Pressurized air flows from the compressor into the ATF® Concentrator Module where it is separated into oxygen and nitrogen components. The air separation process uses a rotary valve system to force air through a series of pressurized sieve beds. Through a process known as “vacuum pressure swing adsorption,” nitrogen molecules are collected on an adsorbent material allowing the concentrated oxygen to be forced through a sieve bed into the product tank. The nitrogen molecules are then purged from the adsorbent material using a vacuum pressure cycle.

Oxygen flows from the product tank through a HEPA filter and past a sensor that measures flow and concentration. A flow control valve regulates the flow of concentrated oxygen presented to the patient. The process is continuously repeated during operation.

COMPRESSOR AND COMPRESSOR ENCLOSURE

The Eclipse Compressor is a two-cylinder, variable speed wobble piston compressor, driven by a highly efficient Brushless DC (BLDC) motor. When air flows into the Compressor enclosure, it passes through an air intake filter/muffler that muffles sound and filters out impurities. Using one cylinder, the compressor takes in filtered air and delivers it to the ATF Module under pressure. The second cylinder draws a vacuum on the ATF module and exhausts nitrogen rich gas to the exhaust vent.

Using a multifaceted approach, sound, heat, and vibration generated by the compressor are mitigated by the compressor enclosure. Vibration and structure-borne noise are addressed by the dual axis gimbal that supports the compressor and the tubing that connects the compressor to the ATF module. The rigid walls of the compressor enclosure and the sound adsorbing foam that lines it diminish the radiated noise. The centrifugal blower mounted within the compressor enclosure serves to efficiently draw cooling air in over the compressor cylinders while simultaneously pushing exhaust gas out of the concentrator.

POWER DISTRIBUTION

The Power Manager takes external power that comes into the Eclipse from the power supplies or Power Cartridge and monitors and controls power distribution to the rest of the Eclipse system. The Power Manager drives the compressor, ATF module motor, blower, and provides power to the Control Board. In addition, when the unit is connected to an external power source, the power manager monitors and controls the recharging of the Power Cartridge.

CONTROL BOARD

The Control Board is at the center of nearly all Eclipse functions. The board constantly monitors dynamics such as temperatures, pressures, product flow and concentration, and user input. It determines proper compressor and ATF motor speeds needed in order to provide optimum system performance. In addition, this system supports the operation of the Control Panel and its indicators.

The Control Board utilizes a proprietary ultrasonic flow and concentration sensor and a flow control valve to accurately control the flow of oxygen in Continuous Flow and Pulse Dose Modes.

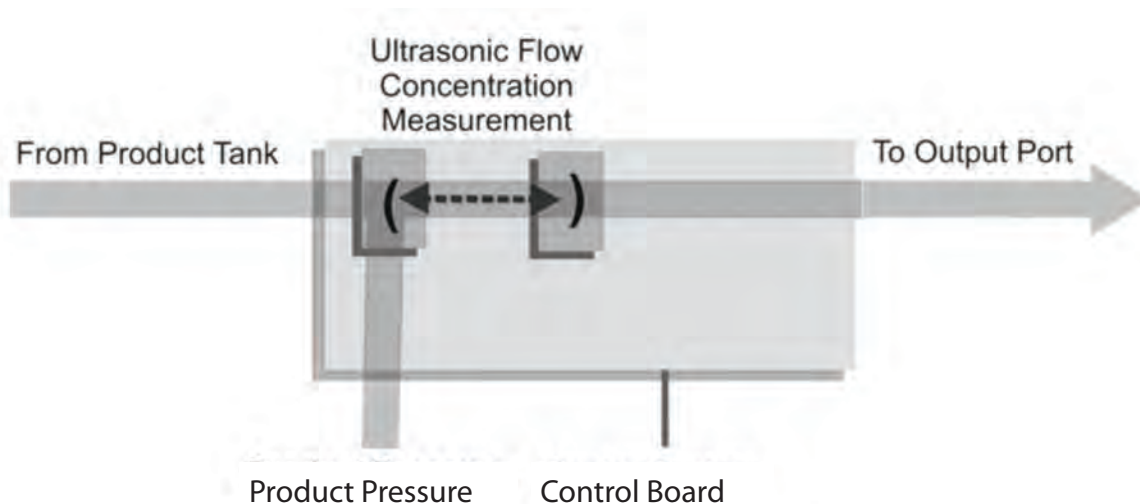

Figure 2: Flow Sensor Board Diagram

CONTROL PANEL

The control panel provides a user interface consisting of a membrane panel keyboard, Liquid Crystal Display (LCD), external power present indicator, Power Cartridge capacity indicator, alarm status indicators, and an audio transducer. The user interface informs the user of the system status and allows the user to set the desired flow rate and flow mode.



Figure 3: User Control Panel

USER CONTROLS AND SYSTEM STATUS INDICATORS

The Eclipse control panel displays important operating information. This section will help you understand this operating information.



ON/OFF Button (Green) Indicator: This button powers the device ON or OFF. The Green Indicator is illuminated when the device is ON.























Increase or Decrease Setting Buttons:
Use these buttons to change prescribed settings.



Delivery Mode Button and Indicator: The button toggles between Continuous Flow and Pulse Dose Mode. The Pulse Dose Mode activates autoSAT Technology—as the patient's breath rate changes, the Eclipse servo-controls the unit to provide a consistent bolus size. The Pulse Dose Mode allows a significant increase in the operating time while powered by the battery. When Pulse Dose Mode is activated, the green Delivery Mode Indicator illuminates and a pulse of oxygen is delivered with each inspiratory effort. When in Continuous Mode, the LED is off.

USER CONTROLS AND SYSTEM STATUS INDICATORS CONT.

Symbol	Definition	Symbol	Definition
	No Smoking Icon (button): Do not smoke near unit. Providers can access provider mode software functions using the Control Panel. All provider mode information is displayed on the LCD. The software shall advance the following Eclipse 3 <i>display mode</i> when the “No Smoking” icon is pressed (see pg. 15).		FAA approved for use aboard passenger aircraft.
	ALERT (Yellow) Indicator—Low and Medium Priority Alerts: When illuminated, this indicates a low priority awareness condition or Caution. Use of the unit may continue and refer to the Troubleshooting Table for the proper response. A flashing yellow indicates a medium priority alert. A prompt response is necessary.		Pulse Mode Operation
	ALARM (Red) Indicator—High Priority Alarms: Indicates a high priority alarm condition. An immediate response is necessary. Refer to the Troubleshooting Table.		Device operating normally; power button
	Flow Setting Indicator: This is the main focus on your control panel. The home care provider will correctly set the prescribed flow for either the Continuous Flow Mode (LPM) and/or the Pulse Dose settings (mL). Each time you power the device ON, the previous mode and/or setting has been saved and will be used at start-up.		Do not get wet.
	Power Cartridge (battery) Status Gauge: This indicator displays the charge remaining in the battery. Each of the five horizontal gray bars represents approximately 20% of the total battery charge. When the battery is being charged, the charge indicator bars will blink in a waterfall-type fashion. If the battery is not installed, or if it is improperly installed, the Power Cartridge (battery) Status Gauge will not be illuminated.		Type B Applied Part (degree of protection against electric shock)
	External Power Indicator: When the Eclipse is properly plugged in and is using the AC or DC Power Supply, this indicator will appear on the User Control Panel.		Use no oil or grease.
	DC Voltage		No open or naked flames.
IPX0	Drip Proof Equipment-IPX0: The Eclipse enclosure does not provide protection against the harmful effects of the ingress of liquids. (IPX0, per IEC 60529)		No serviceable parts inside. Do not open cover.
	Read user manual before operation. See user manual for instructions.		Certified for both the U.S. and Canadian markets, to the applicable U.S. and Canadian standards.
	This symbol is to remind the equipment owners to return it to a recycling facility at the end of its life, per Waste Electrical and Electronic Equipment (WEEE) Directive.		This device complies with the requirements of Directive 93/42/EEC concerning medical devices. It therefore bears the CE marking as shown.
	Name and address of manufacturer		Authorized representative in the European Community

Buzzer:

An audible alarm (or buzzer) is used to alert you to the operating condition of the device, either a warning or failure, and to confirm a valid key press by the user.

CONTINUOUS FLOW MODE

Continuous Flow Mode delivers a constant flow of oxygen to a patient by means of tubing and a nasal cannula at rates between 0.5 LPM and 3.0 LPM. Within the Eclipse, concentrated oxygen is stored in a 500ml product tank at pressures in the range of 5 to 9 psi. This pressure gives Continuous Flow Mode the capability to deliver the indicated flow rate to the patient even if extension tubing is used, up to 50 feet long. In addition, the Eclipse Continuous Flow Mode is fully compatible with humidifier use, with NC not exceeding 7 ft.

PULSE DOSE MODE

The Eclipse Pulse Dose Mode delivers a measured bolus of oxygen at the very beginning of each inspiration. The approach is based on the manner in which gas is absorbed into a patient's airway. Eclipse users may select pulse dose volume delivery rates. Regardless of setting, the pulse profile is a simple square-wave pulse based on a 16 mL volume. (Refer to "Pulse Profiles" table below). Pulse durations are no less than 100 milli-seconds at the beginning of the inspiration. There are three Rise Time settings (Slow, Medium, and Fast). The table below is for the FAST Rise Time setting (factory default is Fast).

Flow Setting	Pulse Peak Flow, LPM (volumetric)	Pulse Duration (milli-second)	Bolus Volume (ml)
1	8	120	16
2	9	213	32
3	10	288	48
4	11	349	64
5	12	400	80
6	13	443	96
128	15	512	128
160	17	565	160
192	19	606	192

Pulse Profiles

The fundamental approach to triggering and controlling the oxygen bolus in Pulse Dose Mode is as follows:

The User may select a pulse trigger sensitivity in settings ranging from 1-3. Bolus volume should be prescribed by a physician and may range from 16mL up to 192mL. The pulse will be triggered when the system meets all of the following criteria:

- The cannula pressure has dropped below the trigger point (typically between 0.15 and 0.45 cm H₂O)
- At least 1¼ seconds has passed since the last pulse began

PROVIDER MODE FUNCTIONS

Providers can access provider mode software functions using the Control Panel. All provider mode information is displayed on the LCD. The software shall advance the following Eclipse 3 **display mode** when the “No Smoking” icon is pressed:

- Alarm Code (ALRM) - Displays most recent alarm code. Additional alarm codes will also be displayed, if present, by continuing to press the + key.
- Pulse Sensitivity (PS)
- Hours of Operation (HRS)
- 9-volt Battery Status (9V)
- Rise Time (BOL)
- Control Board Software Revision (CS)
- Power Manager Software Revision (PM)

ALARM CODE

While in Continuous Flow Mode, pressing the “No Smoking” icon displays the current Eclipse alarm code on the LCD. This code may be used to help diagnose conditions indicated by the alert and alarm indicators. The LCD will show “ALRM=”. Refer to the “Level 1 Maintenance” section for further information.

PULSE MODE SENSITIVITY ADJUSTMENT

During patient setup, a qualified clinician may adjust the Pulse Mode sensitivity to best suit patient inspiratory effort. The LCD will show “PS=x”. PS=1 is the most sensitive setting, PS=3 is the least sensitive setting. Factory default is PS=2.

HOURS OF OPERATION

The Eclipse hour meter provides valuable information on hours of operation. Providers may display the total number of hours of operation using the Control Panel. The display counts up to “99,999” hours, then rolls over to “00000.” The LCD will show “HRS xxxxx”. Refer to the “Level 1 Maintenance” section for further information.

9-VOLT BATTERY STATUS

The status of the 9-Volt Battery is provided. This is the actual voltage of the 9-Volt battery. The LCD will show “9V=x.x”.

RISE TIME (BOLUS DELIVERY)

During patient set up, a qualified clinician may adjust the Rise Time (fast, medium or slow), i.e. how quickly the set bolus volume is delivered. The LCD will display “BOL=”. Factory default is BOL=FAST.

SOFTWARE VERSION

Providers may occasionally need to obtain the software version on the Eclipse to perform maintenance. The provider may display software version numbers for both the Control Board and the Power Manager software using the Control Panel. Refer to the “Level 1 Maintenance” section for further information.

Example: CB394111: Control Board PCB: PN 3941 with Rev 1.1 software
PM593211: Power Manager PCB: PN 5932 with Rev 1.1 software

SERVICE MODE FUNCTIONS

Factory maintenance or service updates may sometimes be required on the Eclipse. Factory and qualified factory-trained technicians can access service mode software functions by using the Service Port located on the back of the unit. The Service Port is not for patient use.

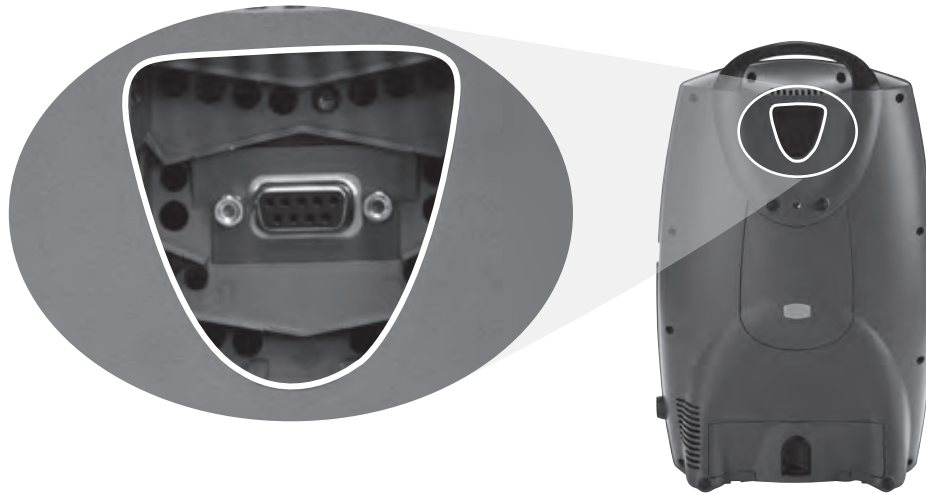

Figure 4: Eclipse Service Port

ECLIPSE DATA ACQUISITION TOOL (EDAT)

EDAT is the world's first computer-based data retrieval service tool for oxygen concentrators. EDAT is proprietary to SeQual Technologies Inc., and is comprised of both hardware and software components. EDAT is SeQual's global solution for your service and support needs.

EDAT software is capable of sensing and displaying historical event logs and values of components and sensors within the Eclipse system. This can be used to determine system faults or user errors and communicate data for troubleshooting or documentation related to service and updates. EDAT hardware attaches or Plugs into the Eclipse Service Port, and into a computer's USB port.

The EDAT software set allows a provider to set-up a hub and spoke service center. Field service reps can travel to a patient's home, troubleshoot and transmit the data to either in-house tech support personnel or SeQual. Support personnel can diagnose, provide solutions and print documentation for equipment records.

EDAT also makes Eclipse software upgrades easy and accessible.

For more information on EDAT, contact Chart-SeQual Technologies Technical Service at 1-800-482-2473 and reference EDAT PN 5535-SEQ.

POWER SUPPLIES

The Eclipse may operate from either the AC or DC Power Supply or the Power Cartridge. When power is available from an external supply, the Eclipse will draw from the external source rather than depleting the Power Cartridge. Connection to external power is indicated when the External Power Present Indicator located on the Control Panel is illuminated.

AC POWER SUPPLY

The AC Power Supply is a universal input type, capable of accepting **100-240VAC, 50/60 Hz**. It is capable of delivering up to 200W of 28VDC output. The input cord requires a grounded receptacle. Country specific cords or universal power adapter PN 5591-SEQ may be used with the AC Power Supply, as the power supply is equipped with a universal input receptacle. When used in a medical care facility, international safety standards require the use of hospital grade AC power cord with the Eclipse.



Figure 5: Eclipse 3 AC Power Supply

The Eclipse 3 AC Power Supply does not contain a fan. When in use, the AC Power Supply should be located in a well-ventilated area.

Located near the output cord, there is a green LED that is illuminated when the AC Power Supply is supplying 28VDC power. If the LED is not illuminated, there is no input power available. In addition, the Power Supply contains protection circuits for output over-current, input over-voltage, and internal over-temperature conditions. If any of these conditions exist, output power will be interrupted and the LED turns off. However, these three conditions are self-resetting, such that output power will resume when protection circuits fall back into acceptable operating ranges.

DC POWER SUPPLY

The DC Power Supply is intended for use with DC accessory outlets, such as those found in motor vehicles. Input voltage to the DC Power Supply is 11.5-18 VDC. Sized to be compatible with most passenger vehicle electrical systems, it is capable of delivering up to 150W of 26VDC output to the Eclipse.



Figure 6: Eclipse 3 DC Power Supply

Located near the output cord, there is a green LED that is illuminated when the DC Power Supply is supplying 26VDC power. If the LED is not illuminated, there is no input power available. The Power Supply contains protection circuits for output over-current, input over-voltage, and internal over-temperature conditions. If any of these conditions exist, output power will be interrupted and the LED will turn off. These three conditions are self-resetting, and output power will resume when protection circuits fall back into acceptable operating ranges. The power supply will not charge the battery or operate the Eclipse above 2 LPM continuous or 96 mL in pulse dose while operating power on DC.

DO NOT use the DC supply to power the Eclipse once the vehicle's engine is turned off as this may drain the car's battery.

POWER CARTRIDGE (BATTERY)

The Power Cartridge allows operation away from AC or DC power. The Power Cartridge used with the Eclipse contains Lithium ion battery cells, similar to those used in laptop computers and cell phones. The Eclipse Power Cartridge contains a quantity of two 97.5 Watt hour battery packs. Each battery pack contains 7.92 grams of equivalent lithium content.



Figure 7: Eclipse 3 Power Cartridge

The Power Cartridge (Battery) may be charged in two ways: (a) place the Power Cartridge in the Eclipse and connect the Eclipse to AC power, or (b) place the Power Cartridge in the optional Desktop Charger (PN 7112-SEQ).

Operating and servicing the Power Cartridge will ensure longer life and higher performance. It is important to follow the tips and recommendations when storing and operating the Eclipse on the Power Cartridge.

The Eclipse Power Cartridge operation time may be affected by several factors such as bolus size, breathing rates, ambient temperature, age of power cartridge and use over time. The table below describes the typical operating time for a new Power Cartridge.

If the Eclipse is used in Pulse Dose Mode, there will be longer operating time. The patient should consult their physician for a prescription for Pulse Dose Mode.

TYPICAL NEW POWER CARTRIDGE OPERATING TIMES

(At nominal temperature of 25°C/77°F)

FLOW RATE SETTING	Continuous Flow (LPM)	mL SETTING	Pulse Dose Mode (12 BPM)
0.5	4.4 hours	-	-
1.0	3.7 hours	16mL 1.0	5.4 hours
2.0	2.0 hours	32mL 2.0	5.1 hours
3.0	1.3 hours	48mL 3.0	4.9 hours
		64mL 4.0	4.0 hours
		80mL 5.0	3.7 hours
		96mL 6.0	3.5 hours
		128mL	2.5 hours
		160mL	2.0 hours
		192mL	1.7 hours

Battery Consumption Chart

NOTE: Battery times will decrease with higher bolus size, breath rate, ambient temperature, Battery age and use over time.

The Power Cartridge packaged with the Eclipse is not fully charged. Before using the Eclipse Oxygen System for the first time, the Power Cartridge must be fully charged.

Store the power cartridge in a cool, dry location. Do not leave the Eclipse or Power Cartridge in a vehicle or trunk during a hot or cold day.

When checking the Eclipse as baggage on a commercial airline flight for international travel, remove the Power Cartridge and properly package.

When shipping the Eclipse for any reason, remove the Power Cartridge from the Eclipse.

If the Power Cartridge gets too warm, charging will not begin until the Power Cartridge sufficiently cools. Consider removing the Power Cartridge to allow for faster cooling.

The Power Cartridge operating time is longer if the Eclipse is operated in Pulse Dose Mode. (Refer to Battery Consumption Chart above.)

The typical time to recharge the Power Cartridge to achieve 80% capacity from a fully discharged Power Cartridge is 1.8 hours to 5.0 hours, dependent upon the flow setting.

The Power Cartridge will not charge when operating from the DC Power Supply.

The capacity of the Eclipse Power Cartridge is determined by electronics and the Eclipse software.



WARNING:		<u>DO NOT</u> tamper with, disassemble, crush or heat the Power Cartridge above 140° F (60° C). The Power Cartridge may present a risk of fire or explosion and will void the warranty.
CAUTION		Store the Power Cartridge in a cool, dry place when not in use.
CAUTION		<u>DO NOT</u> leave the Eclipse or the Power Cartridge in a vehicle or in the trunk during a hot or cold day.
CAUTION		The Eclipse system can only work with a SeQual Power Cartridge. Use of another Power Cartridge or Battery may damage the unit, present a risk of fire or explosion and will void the warranty.



Figure 8: Power Cartridge Status Gauge

While the Eclipse Power Cartridge allows the concentrator to operate at its full range of capabilities, the primary purpose of the Power Cartridge is to allow a patient to ambulate while they are moving between stationary power sources. The Eclipse's Power Cartridge, like all lithium ion batteries, is susceptible to permanent damage from excessive heat. Exposure to excessive heat may significantly shorten the service life of the Power Cartridge.

Each Power Cartridge contains multiple temperature sensors to monitor battery cell temperature. The amount of heat the Power Cartridge can safely endure varies depending on how the Power Cartridge is being used. During discharge, the Eclipse software will alarm when internal battery cell temperature exceeds 60°C, and will shut the system down if internal battery cell temperature exceeds 70°C. While the Power Cartridge is charging, software will interrupt charger operation when the internal battery temperature exceeds 45°C or temperature is less than 0°C. In both of these cases, when internal battery cell temperature falls within these limits, the Eclipse will resume normal operation. Operation near these temperature limits will not damage the Power Cartridge, but are in place to ensure that the service life of the Power Cartridge is preserved.

Heat in the Power Cartridge is generated during discharge, and can also be the result of operating the Eclipse in high ambient temperatures. The amount of internally generated heat varies with the flow setting – higher flows induce greater Power Cartridge heating. While high ambient temperatures are typically the result of operation on a hot day, running the Eclipse with inadequate ventilation can also add additional heat. Always ensure that the Eclipse is operated in a well-ventilated space, the air intake filter is clean, and intake and exhaust vents are unobstructed.

CHARGING ALGORITHM

The charging algorithm is performed by the Power Manager software and involves three basic decisions:

1. When to start charging
2. How fast to charge
3. When to stop charging

Charging begins when Power Cartridge voltage falls below 16.0 volts.

The charging current is limited by the charger capability and the rated capacity of the Power Cartridge. Under certain conditions, the Eclipse may not have enough external power available to charge the batteries at the full rate. In this case, the charging rate will be limited to the available power.

As the Power Cartridge accumulates charge, the charging current required will eventually fall. When the charging current for each Power Cartridge has fallen below 5% of the rated capacity, charging is complete and the Power Cartridge charger is shut off.

The software will only charge when the Power Cartridge temperature is at or below 45°C. The software will always run the cooling fan whenever the charger is enabled. The Power Cartridge charger is disabled and the cooling fan is set to maximum whenever the Power Cartridge temperature exceeds 45°C. The Power Cartridge charger is disabled when temperature is less than 0°C.

All lithium ion batteries self-discharge at very low rates when not in use. Eclipse Power Cartridges are shipped from SeQual in a partially charged state (nominally 40%). When stored in a cool, dry location, the Power Cartridge can sit unused for up to 12 months without appreciable self-discharge occurring. Nevertheless, SeQual recommends a first in, first out rotation of Power Cartridge inventory for maximum Power Cartridge service life.

Training The Patient

INTRODUCTION

Welcome to the Eclipse 3, Personal Ambulatory Oxygen System with autoSAT Technology. Setting up and training your patient to use the Eclipse has never been easier! You can expect your patients and care providers to easily learn how to use the device by following the directions in this section. While setting up and training a patient, be sure to point out the advantages of the Eclipse. For example:

- Slim and sleek appearance
- Easy-to-use controls
- Quiet operation
- Lower electric bills
- Self-monitoring alarm system
- More consistent FiO₂ at higher breath rates

After completing each training procedure, ask your patient if he or she has any questions. Proper training of your patients will result in fewer service calls, improved compliance and increased patient satisfaction.

PRE-DELIVERY CHECK LIST

Before delivering the device, check and log the status of the following:

■ **Parts Inventory** – Verify that each Eclipse is provided to the patient with the following items:

- | | |
|---------------------|------------------------------|
| ✓ Users Manual | ✓ AC Power Cord |
| ✓ Quick Start Guide | ✓ AC Power Supply |
| ✓ Eclipse Passport | ✓ DC Power Supply |
| ✓ Universal Cart | ✓ Power Cartridge (Battery) |
| ✓ Cannula | ✓ Air Inlet Filter and Spare |

■ **Power Sources** – Insert and check the following for proper operation:

- ✓ AC Power Supply with Power Cord
- ✓ DC Power Supply
- ✓ Power Cartridge (Battery)

■ **Electrical System** – Use the Control Panel to check and/or adjust the following:

- | | |
|---------------------------|--------------------------------|
| ✓ Pulse Dose Setting | ✓ 9V Battery Status |
| ✓ Continuous Flow Setting | ✓ Rise Time |
| ✓ Hour meter | ✓ Software Revision |
| ✓ Pulse Dose Sensitivity | ✓ Power Cartridge Status Gauge |

The Eclipse 3 is shipped from SeQual at default flow settings of 2 LPM Continuous Flow, 2.0 Pulse Dose, and 2 for Pulse Mode Sensitivity Adjustment and FAST Rise Time. You may adjust these settings to your patient's prescription when you deliver and set up the device.

INDICATIONS FOR USE

The Eclipse is indicated for the administration of supplemental oxygen. The device is not intended for life support nor does it provide any patient monitoring capabilities.

A physician must prescribe a specific oxygen flow rate setting to meet patients' individual needs.

Recommended oxygen flow rates should be adjusted only under the advice of a physician.

WARNING:	Federal law restricts this device to sell by or on the order of a physician.
	

CONTRAINDICATIONS

WARNING:	The Eclipse is not intended for life supporting or life sustaining applications, nor does it provide any patient monitoring capabilities.
	

WARNING:	In certain circumstances, the use of non-prescribed oxygen can be hazardous. This device should only be used when prescribed by a physician.
	

WARNING:	Not for use in the presence of flammable anesthetics.
	

WARNING:	As with any electrically powered device, the user may experience periods of non-operation as a result of electrical power interruption, or the need to have the Eclipse serviced by a qualified technician. The Eclipse is not appropriate for any patient who would experience adverse health consequences as a result of such temporary interruption.
	

BASIC CONCEPT TRAINING

The following section is intended to assist the provider to train the patient or caregiver to use the Eclipse. Topics in this section should be discussed with each patient prior to release for use of the Eclipse.

SAFETY GUIDELINES AND OPERATIONAL SAFETY WARNINGS & CAUTIONS

Provider should review all safety guidelines and operational safety Warnings/Cautions with each patient. In addition, provider should carry out a risk assessment prior to installation of the Eclipse to assure proper connection and compatibility with other equipment the patient may be using.

WARNING:	

No Smoking or Open Flames. For safety concerns, all possible sources of ignition must be kept away from the oxygen system and preferably out of the room in which it is being used. Smoking in the proximity of an operating oxygen concentrator is dangerous and can permanently damage the device and void the warranty. Keep the Eclipse at least five (5) feet (1.5 m) from heat sources, sparking objects or open flames.

LOCATING THE ECLIPSE FOR PROPER USE AND VENTILATION

Ask your patient where they would like to set up the device. Whenever possible, the Eclipse should be in the same room as the patient for convenience and assurance that the patient can adequately hear and respond to Eclipse alerts and alarms. While unpacking and setting up the device, tell your patient about these important cautions and warnings:

WARNING:	

- Locate the Eclipse in a well-ventilated space that provides adequate airflow.
- Ensure that furniture, draperies or clothing will not impede air circulation.
- Avoid placing the unit over a floor heat register or against a baseboard heating system.
- Do not use in the presence of flammable anesthetics, solvents, aerosols or flammable cleaning agents.
- Avoid high pollutant environments.

CAUTION	

Some patients are highly mobile and may use the device under varying circumstances. Make sure your patient or patient caregiver completely understands the basic precautions to safely locate the device.

NOTE:	After completing this training procedure, ask your patient if s/he has any questions.
--------------	---

THE USERS MANUAL

Give your patient a copy of the Eclipse 3 Users Manual and advise them to read prior to operating. Open the manual and briefly review the Table of Contents, including subheadings. Show your patient the icons and symbols and explain what each means.

CAUTION	

Advise your patient to thoroughly read the Eclipse 3 Users Manual and keep the manual in a safe place for future reference.

SHOWING PANEL BUTTONS, INDICATORS, ALERTS AND ALARMS

Open the Users Manual to the section on "UNDERSTANDING THE CONTROLS AND FRONT PANEL" and show your patient where each button is located on the Eclipse Control Panel and how each button and indicator operates. Go over the alerts and alarms and how to handle alert and alarm conditions. Detailed instructions for each button and indicator can be found in the Eclipse Users Manual.

SHOWING POWER CARTRIDGE POWER LEVEL

The display on the Control Panel shows the amount of Power Cartridge capacity available and waterfalls when charging. Point out the table showing typical new Power Cartridge duration-of-use time in the Users Manual.

WARNING:	<p>The display gives an <i>approximate</i> level of remaining battery power. If the patient is dependent on oxygen therapy, the users should always have a backup oxygen supply or access to AC or DC Power Supply in the event of loss of battery power.</p>
	

SELECTING THE PROPER FLOW MODE AND SETTING

The recommendations of the qualified clinician responsible for the patient's care should always be followed when instructing patients on the use of Continuous or Pulse Dose Mode.

WARNING:	<p>Do not attempt to prescribe oxygen level settings. Warn your patient that only a qualified clinician or physician is qualified to perform the necessary tests to prescribe treatment.</p>
	

SELECTING CONTINUOUS FLOW MODE

When delivered from SeQual, the Eclipse is set to Continuous Flow Mode. Refer your patient to the Users Manual for instructions on how to select Continuous Flow Mode. Demonstrate the procedure on the device. Set the prescribed flow using the increase or decrease flow rate buttons

CAUTION	<ul style="list-style-type: none"> • Continuous Flow Mode is required in order to use a humidifier bottle. • Continuous Flow Mode without a humidifier bottle is required in order use 50 foot tubing.
	

SELECTING PULSE DOSE MODE

Pulse Dose Mode, delivers a measured bolus of oxygen pulse at the beginning of each inspiration. Refer to the Users Manual for instructions on how to select Pulse Dose Mode. Demonstrate the procedure for your patient. Set the prescribed flow using the increase or decrease buttons. Verify that the patient is able to adequately trigger the oxygen delivery while speaking, sitting quietly, and walking. If the patient is not able to satisfactorily trigger oxygen delivery, the Pulse Sensitivity may need to be adjusted.

CAUTION	<ul style="list-style-type: none"> • Do not use a humidifier when in Pulse Dose Mode. • Use only a 7-foot cannula when in Pulse Dose Mode. Do not use a tubing extension.
	

Review with the patient the breath rate capabilities of Pulse Dose Mode for their prescription.

‘POWER CARTRIDGE (BATTERY) CONSERVATION’ FEATURE

While in Pulse Dose Mode, the Eclipse 3 is always monitoring for breath detection. After 15 seconds of no breath detected, the Eclipse 3 “delivers” Continuous Flow at the last Continuous Flow setting. The system and display are still in Pulse Dose Mode and the green Delivery Mode Indicator is blinking fast, indicating you are receiving a Continuous Flow. After 15 seconds, the Eclipse 3 stops delivering Continuous Flow and waits 15 seconds for a breath. If a breath is detected, then the Eclipse 3 will go back to Pulse Dose Mode. If a breath is not detected, the Battery Conservation function will continue; 15 seconds Continuous Flow, 15 seconds Pulse Dose Mode. The Eclipse 3 will stay in this modality until a breath is detected.

This power management feature of the Eclipse 3 greatly conserves the operating life of the battery, extending therapy time and patient mobility.

ADJUSTING THE PULSE DOSE MODE SENSITIVITY SETTING

The oxygen delivery trigger sensitivity may be adjusted to satisfy patient requirements, by selecting setting 1, 2 or 3 (1=most sensitive, 3=least sensitive). The default setting for units coming from SeQual is “2”. To adjust the Pulse Sensitivity, perform the following steps:

1. Have the patient sit quietly, with the nasal cannula properly fitted.
2. Put the Eclipse into Pulse Dose Mode at the patient’s prescribed flow setting.
3. Press the “No Smoking” icon until the “PS=” value is displayed.
4. Press the “+” or “-” buttons to raise or lower the sensitivity (1=most sensitive, 3=least sensitive.)
Raising the sensitivity will require additional inspiratory effort to trigger the oxygen pulse.
Lowering the sensitivity will require less inspiratory effort to trigger the oxygen pulse.
 Too low of a setting may result in false triggering.
5. Verify that the patient is able to adequately trigger the oxygen delivery while speaking, sitting quietly, and walking. Steps 1-6 may be repeated until the patient is able to adequately trigger oxygen delivery.

WARNING:	As with all conserving devices, the Eclipse may not be able to detect some respiratory efforts.
	

NOTE:	The Eclipse requires a minimum of one minute to stabilize after a change. After a setting change, always wait at least one minute before determining if another adjustment is necessary.
--------------	--

ADJUSTING RISE TIME

The adjustable Rise Time feature on the Eclipse 3 was designed for patient comfort. The Rise Time feature adjusts flow and speed of bolus delivery, and determines how quickly the patient receives their bolus volume while in Pulse Dose Mode. The Eclipse 3 offers delivery settings of FAST, MEDIUM, and SLOW. The factory default setting is FAST, and is equivalent to the delivery settings of the Eclipse and Eclipse 2 models. A MEDIUM or SLOW rise time may be appropriate for certain patients, and should be determined and set by a trained clinician. Adjusting the Rise Time will not affect the chosen volume of oxygen delivered to the patient (16-192 mL).

CONNECTING THE AC POWER SUPPLY

The Eclipse operates from external power when connected to a power outlet.

To connect the Eclipse to the AC Power Supply, follow these steps:

1. Insert the AC supply plug tip into the Eclipse.
2. Insert the power cord into the AC Power Supply.
3. Plug the power cord into a grounded outlet.
4. The power supply LED displays green to indicate that the AC Power Supply is drawing power. The External Power Present Indicator on the Control Panel illuminates. 

NOTE:	If the Power Supply Status LED is not illuminated after inserting the plug into a grounded outlet, check to make sure the Power Supply and power cords are securely plugged into the Eclipse.
--------------	---

WARNING:	<ul style="list-style-type: none"> • Ensure adequate clearance around the AC Power Supply. • The AC Power Supply is universal input, but the AC power cord is appropriate to specific country's electrical service. Ensure that power cord is appropriate to country's electrical service.
	

CAUTION	<ul style="list-style-type: none"> • DO NOT connect the Eclipse to an extension cord or electrical outlet controlled by a switch.
	

NOTE:	When removing the AC Power Supply from the Eclipse, remove the plug from the AC outlet before removing the AC Power Supply plug from the Eclipse.
--------------	---

International safety standards require the use of hospital grade AC power cords (3893-SEQ) when using the Eclipse in a medical care facility. Contact Chart SeQual to obtain a hospital grade AC power cord for the Eclipse if necessary.

CONNECTING THE DC POWER SUPPLY



To install the DC Power Supply, follow these steps:

A DC Power Supply allows the system to operate from DC outlets, such as those found in motor vehicles.

CAUTION	<p>The DC Power Supply is designed for 12VDC minimum vehicle electrical systems. Do not attempt to operate with 6V, 24V, or other vehicle electrical system.</p>
	

1. Consult your patient's vehicle owner's manual for DC Accessory outlet requirements.
2. Secure your Eclipse and DC Power supply in your vehicle. Ensure that alerts and alarms are observable.
3. Start the vehicle's engine.
4. Insert supply plug into DC accessory outlet.
5. Attach the Power Supply plug to the Eclipse.
6. Advise the patient to use Pulse Dose Mode if prescribed by their clinician.
7. When the device is properly connected and receiving power from the DC power source, a green indicator light on the DC Power Supply will illuminate.

Ask your patient whether he or she will be using the device to travel by vehicle. If so, show your patient how to safely use the Eclipse while driving. Refer to the previous section on Connecting the DC Power Supply for proper setup of the Eclipse system in a vehicle.

WARNING:	<ul style="list-style-type: none"> • Ensure adequate clearance around the DC Power Supply and the Eclipse. • Ensure the DC Power Supply and Eclipse are secured in the vehicle so that it does not become a projectile in the event of a sudden stop. • DO NOT operate the Eclipse on DC power while the vehicle engine is off. In such a scenario, the Eclipse could quickly drain the vehicle's battery.
	
CAUTION	<p>When operating with an Eclipse 3 DC Power Supply, Eclipse settings greater than 2.0 LPM Continuous Flow, will automatically switch to the 2.0 LPM Continuous Flow setting. 2.0 LPM is max. Pulse mode will also not operate above 96 mL.</p>
	

When the Eclipse is running from an external (AC or DC) power supply, the External Power Present Indicator will illuminate.



The Eclipse will always operate from external power when external power within the specified range is available.

ACTIVE LIFESTYLE TRAINING

Small, lightweight, and easily moved about, the Eclipse 3 is ideally suited to an active lifestyle. The AC supply enables recharge of the Power Cartridge during longer excursions and even extended overnight travel. To train your patient on mobility and ambulation, follow the procedures below.

CAUTION	Always check to see that the Air Inlet and the Exhaust Vent are not blocked and the Air Inlet Filter is dry and clean before using your Eclipse.
	
NOTE:	<ul style="list-style-type: none"> • Do not drop the Eclipse or Eclipse power supplies. If dropped or damaged, verify unit performance. • The Eclipse will not detect a cannula that has been disconnected from the Oxygen Outlet Port.

ATTACH THE UNIVERSAL CART

Your patient will enjoy the mobility offered by the Eclipse Universal Cart in and outside the home. Show your patient how to perform the following important activities:

- Mounting the Eclipse to the Universal Cart
- Extending and collapsing the telescoping handle

CAUTION	Do not lift the Eclipse by the cart handle.
	

USING AROUND THE HOUSE

Your patient may use 50' tubing when operating the Eclipse in the house. In order to use extended tubing, the device must be in Continuous Flow Mode. When a humidifier is used, the tubing between it and the patient must not exceed 7'.

CAUTION	When using a humidifier adapter of any kind, the Eclipse unit must remain stationary, meaning that the unit must NOT be moved or transported in any manner.
	

TRAVELING BY VEHICLE

Ask your patient whether he or she will be using the device to travel by vehicle. If so, show your patient how to safely use the Eclipse while driving. Refer to the previous section on Connecting the DC Power Supply for proper setup of the Eclipse system in a vehicle.

NOTE:	Whenever possible, go to your patient's vehicle to demonstrate this procedure.
--------------	--



Figure 9: Eclipse 3 DC Power Supply

CAUTION	Be sure to accurately determine the amount of current the vehicle accessory outlet is rated to supply.
	

WARNING:	<ul style="list-style-type: none"> • Avoid placing the Eclipse in direct sunlight. • Do not store the Eclipse in a vehicle where the device may be subject to extreme temperatures. Extreme heat or cold may impair operation and damage the device and degrade the Power Cartridge. • When using the Eclipse in a vehicle, check the cannula to make sure it is not pinched or occluded.
	

Use the following table to determine whether your patient's prescribed flow setting is supported by the Eclipse while on DC power.

FLOW SETTINGS AVAILABLE WHEN OPERATING ON DC

Flow Setting	Continuous	Setting / Bolus Size (mL)	Pulse Dose
0.5	Yes	0 / -	-
1.0	Yes	1 / 16	Yes
1.5	Yes	1.5 / 24	Yes
2.0	Yes	2 / 32	Yes
2.5	NO	2.5 / 40	Yes
3.0	NO	3 / 48	Yes
-	-	3.5 / 56	Yes
-	-	4 / 64	Yes
-	-	4.5 / 72	Yes
-	-	5 / 80	Yes
-	-	5.5 / 88	Yes
-	-	6 / 96	Yes
-	-	128	NO
-	-	160	NO
-	-	192	NO

Flow Modes for DC Power Supply Operation.

NOTE: Actual performance of the Eclipse may vary depending upon usage conditions of the motor vehicle.

CAUTION	When operating with an Eclipse 3 DC Power Supply, Eclipse settings greater than 2.0 LPM Continuous Flow, will automatically switch to the 2.0 LPM Continuous Flow setting. 2.0 LPM is max. Pulse mode will also not operate above 96 mL.
	

TRAVELING BY AIR

TRAVEL APPROVED

The Eclipse is an FAA approved portable concentrator.

A new US Department of Transportation regulation regarding portable oxygen concentrators took effect on May 13, 2009. Under this regulation, every FAA approved portable concentrator is now authorized for use during any commercial flight that departs or arrives in the USA, regardless of whether the airline itself has approved the device or not.

When traveling by air, instruct your patient to remove the Power Cartridge from the Eclipse before checking the unit as checked baggage or cargo. Transport of the Eclipse as cargo or checked baggage with the Power Cartridge installed is prohibited by international air cargo regulations.

The Power Cartridge may be installed if the patient is using the Eclipse as a carry-on item.

If the airline allows use of the Eclipse Oxygen System, only operate the Eclipse from the Power Cartridge. DO NOT use DC or AC Power Adapters on an aircraft. The patient must ensure that they have an adequate number of spare Power Cartridges to last for the duration of their trip.

Visit our website, www.sequal.com to the Travel Approved section, for helpful travel tips, forms used to assist with traveling and estimated number of Power Cartridges (batteries) needed for flights.

Each airline has their own requirements and SeQual recommends checking those requirements prior to making a trip.

TRAVELING BY CRUISE SHIP

When traveling by watercraft, instruct your patient to inform the cruise line that the Eclipse will be used onboard. Each cruise line has a Special Needs coordinator that can answer any questions regarding travel and the cruise line's individual requirements. Have your patient contact the cruise ship Special Needs Coordinator directly.

TRAVELING BY TRAIN

When traveling by train, instruct your patient to inform the rail line in advance that the Eclipse will be used onboard. Operate the Eclipse only from the Power Cartridge. The patient must ensure that they have an adequate number of spare Power Cartridges to last for the duration of their trip.

ECLIPSE MAINTENANCE

WEEKLY MAINTENANCE—PATIENT

Training your patient to maintain the Eclipse properly will lead to longer service intervals and lower maintenance costs. Train your patient to perform the following procedures:

CLEAN THE AIR INLET FILTER

The Air Inlet Filter, located at the rear of the unit, must be cleaned at least once a week.

To clean the filter:

1. Remove the filter from the back of the cabinet.
2. Wash the filter in warm water using a mild detergent solution.
3. Rinse the filter thoroughly and squeeze out the excess water.
4. Allow the filter to air dry thoroughly.
5. Re-insert the filter in the cabinet.
6. Maintenance may be easier for the patient when a second filter is provided.



Figure 10: Cleaning the Air Inlet Filter

CAUTION	<ul style="list-style-type: none"> • The filter should be completely dry before using it again. Excess moisture may impair proper operation or damage the unit. • Replace the Air Inlet Filter annually. If the Eclipse is operated in a dusty environment, the filter may need to be cleaned or replaced more often. Do not operate the Eclipse for more than 30 minutes without a filter installed.

CLEAN AND CARE FOR THE TUBING AND CANNULA

Provide your patient instructions on cleaning, disinfection and/or replacement information for the tubing and cannula.

CLEAN THE CABINET AND CONTROL PANEL AND POWER SUPPLIES

To clean the cabinet, Control Panel or power supply, do the following:

1. Turn OFF the Eclipse and disconnect from AC or DC power before any cleaning or disinfection activity.
2. Use mild detergent and water solution.
3. Use a damp (not soaking wet) cloth or sponge.
4. Spray or wet the cloth or sponge with the mild detergent solution. DO NOT spray the cabinet, Control Panel or power supplies.
5. Wipe down the cabinet, Control Panel or power supplies.
6. To disinfect the Eclipse, use Lysol® Brand II disinfectant (or equivalent). Spray or wet a cloth or sponge with the disinfectant. DO NOT spray the cabinet, Control Panel or power supplies. Proceed as directed by the manufacturer.

MONTHLY MAINTENANCE—PATIENT

CARE FOR THE POWER CARTRIDGE

The Power Cartridge (battery) in the Eclipse requires special care to assure a longer life and the highest level of performance. The SeQual Power Cartridge is the only approved Power Cartridge recommended for use with the Eclipse. The following are generic guidelines for the Power Cartridge:

- Avoid high temperatures
- Avoid cold temperatures
- Do not drop Power Cartridge
- No not poke objects into contacts

Power Cartridge Cleaning: Use a damp (not soaking wet) cloth or sponge. First spray the cloth or sponge with a mild detergent and then clean the Power Cartridge case and the latch.

WARNING:	Exposing the Power Cartridge to water or other liquids may cause personal injury or harm.
	DO NOT tamper with or try to repair the Power Cartridge. There are no serviceable parts inside.

Power Cartridge Storage: The Power Cartridge should be stored in a cool and dry location.

CALIBRATING THE POWER CARTRIDGE

In order to maintain the Power Cartridge, your patient should fully discharge the Power Cartridge once a month. In order to accurately maintain the Eclipse Power Cartridge, periodic full discharge of Power Cartridge to zero is recommended. This serves to calibrate the Power Cartridge Status Indicator. To do this, the patient will need an AC Power Supply to recharge the Power Cartridge and should be able to run the Eclipse from AC power for at least 5 hours.

NOTE:	The patient can still use the Eclipse while zeroing the Power Cartridge.
--------------	--

The patient should follow these steps:

1. Install the Power Cartridge in the Eclipse
2. Remove external power and operate the Eclipse from the Power Cartridge
3. Allow the Eclipse to completely discharge the Power Cartridge. This is best performed at a setting of 2.0 LPM Continuous Flow. Ten to fifteen minutes before the end of the discharge cycle, the “Low Power Cartridge” alert will sound, followed by the “Power Cartridge Shutdown” alarm. If using the Eclipse while discharging the Power Cartridge, DO NOT deviate from the patient’s prescription.
4. Press the ON/OFF button to silence the alarm.
5. Allow the cartridge to cool for a minimum of 1 hour prior to recharging.
6. Reattach external power. Verify that the External Power Present Indicator illuminates. Leave the Power Cartridge installed. Note that the Power Cartridge Status Gauge may not indicate charging immediately. When the Power Cartridge reaches proper temperature, charging will begin automatically.
6. Allow Power Cartridge to fully charge, as indicated by the Power Cartridge Status Gauge.

NOTE:	<ul style="list-style-type: none"> • If the Power Cartridge temperature rises above 45°C (113°F), the Power Cartridge will not charge. • If the Power Cartridge temperature rises above 70°C (158°F), the Power Cartridge will not discharge.
--------------	---

PATIENT TRAINING CHECKLIST

Use the following checklist as a guide to assist in setup and training a patient on the use of the Eclipse 3™ with autoSAT™ Technology and its accessories.

Patient Name:	
Eclipse Serial #	DC Power Supply Serial #
AC Power Supply Serial #	Power Cartridge Serial #
Training Topic	Initials
Pre-Delivery Check List	
Indications for Use	
Contraindications	
Basic Concept Training	
Advise to read the Users Manual	
Go over all accessories included with the Eclipse: AC, DC, Power Cord, Cart, Battery	
Safety Guidelines and Operational Safety Warnings/Cautions	
Locating the Eclipse	
Panel Buttons and Indicators	
Alerts and Alarms	
Power Cartridge Power Level	
Selecting Flow Mode and Setting	
• Selecting Continuous Flow Mode	
• Selecting Pulse Dose Mode with autoSAT Technology	
• Adjusting the Pulse Dose Mode Sensitivity Setting	
• Selecting Rise Time	
• Battery Conservation feature	
Connecting the AC Power Supply	
Connecting the DC Power Supply	
Active Lifestyle Training	
Attach the Cart	
Changing Power Cartridge (Battery)	
Use Around the House	
Traveling by Vehicle	
Traveling by Air	
Traveling by Boat	
Traveling by Train	
Eclipse Maintenance	
Weekly: Clean the Air Inlet Filter	
Weekly: Clean and Care for the Cannula	
Weekly: Clean the Cabinet and Control Panel	
Monthly: Care for the Power Cartridge	
Annually: Schedule PM at least once a year	
Trained By:	Date:

Annual Maintenance—Provider

INTRODUCTION

Properly maintaining the Eclipse will ensure longer life and higher performance. Minimum annual maintenance is required.

CAUTION	The Eclipse contains electrostatic sensitive components. Do not open or handle except at a static free workstation. Do not remove cover without ESD protection.
	

ANNUAL MAINTENANCE CHECK LIST

Perform the following maintenance procedures at least once a year or more often., as needed. The frequency of the periodic maintenance should be based on the environment in which the Eclipse is used.

- Replace air inlet filter
- Check Power Cartridge
- Inspect AC and DC Power Supply plugs and cords for damage. Replace as needed
- Verify that the AC and DC Power Supplies operate with the Eclipse
- Readjust the Pulse Dose Sensitivity setting between patients as needed
- Readjust the Rise Time setting between patients, as needed
- Replace 9V battery
- Check Universal Cart for functioning wheels and telescoping handle. Replace as needed
- Read and record hour meter
- Check flow rate, purity, Pulse Dose Mode and alarm functions
- Replace compressor intake filter
- Perform electrical safety test (Required only for PN 5701, Hospital Grade Power Cord)
- Replace HEPA filter

CHECKING AND REPLACING THE POWER CARTRIDGE

Typically, the Power Cartridge will require no routine maintenance beyond cleaning by the patient and calibration. SeQual recommends that the Power Cartridge be replaced if there is physical damage to the cartridge enclosure or connector, or if the battery's recharge capacity, after calibration, is 20% less than published values at its given flow rate.

ECLIPSE MONTHLY RUN-TIME PROCEDURE

1. Power on Eclipse using AC Power, DC Power, or Power Cartridge
2. Allow unit to run for a minimum of 2 hours

NOTE:	This procedure is performed to ensure and prolong the life of your Eclipse. This is also an ample opportunity to calibrate the power cartridge of the Eclipse.
--------------	--

ANNUAL MAINTENANCE PROCEDURES

The following section lists procedures that are necessary to maintain the Eclipse. Service should only be performed by a qualified technician. To perform periodic maintenance, the only tools that should be necessary are:

- #1 Phillips Screwdriver
- Wire-cutting pliers
- Small cable ties
- ESD Mat or approved ESD system

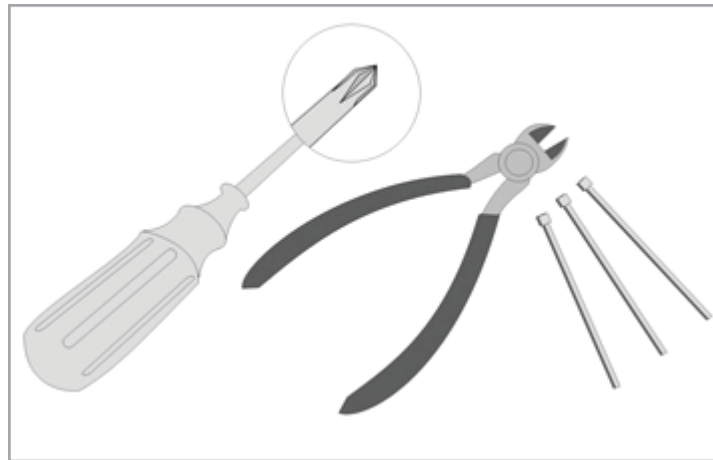



Figure 11: Maintenance Tools.

REMOVING THE UNIT COVER

1. Disconnect power supplies and remove Power Cartridge before removing the unit cover.
2. Place the unit horizontally on the front cover.
3. Using a Phillips #1 screwdriver, remove a total of 10 screws (M3x12 Pan Head SEM Screw, P/N 6974-312-SEQ) from the back of the unit.

WARNING:	
	<ul style="list-style-type: none"> • Keep hands out of moving parts • Disconnect power supplies and remove Power Cartridge before removing the unit cover. • ESD Safety procedure must be in place.

CAUTION	The Eclipse contains electrostatic sensitive components. Do not open or handle except at a static free workstation. Do not remove cover without ESD protection.
	

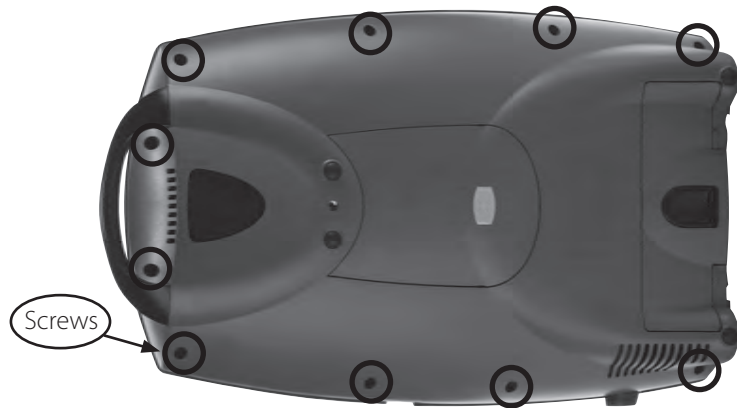

Figure 12: Removing screws to open the Front Cover

4. Turn over and place the unit horizontally on the back cover.
5. Remove the front cover -- pop the bottom end off first and rotate it towards the handle. Be careful not to tear the Control Panel ribbon cable that is attached to the front cover.

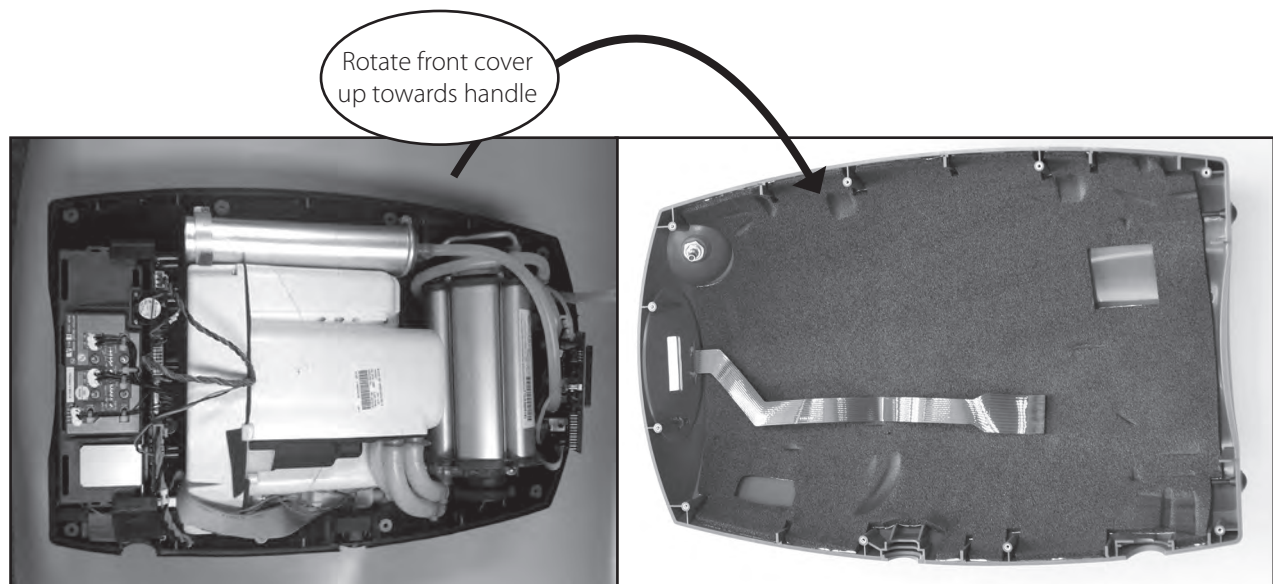



Figure 13: Opening the Front Cover.

6. Disconnect the cable from the Control Panel as follows:

- a. Grasp the circuit board firmly between your fore fingers and thumb.
- b. Grasp the head of the Membrane Panel Overlay cable in your other hand.
- c. Firmly pull the cable away from the board. Pull the cable straight out. Do not rock the connector back and forth. This may damage the pins of the header.

CAUTION	Do not disconnect the Membrane Panel Overlay cable by pulling on the ribbon cable.
	

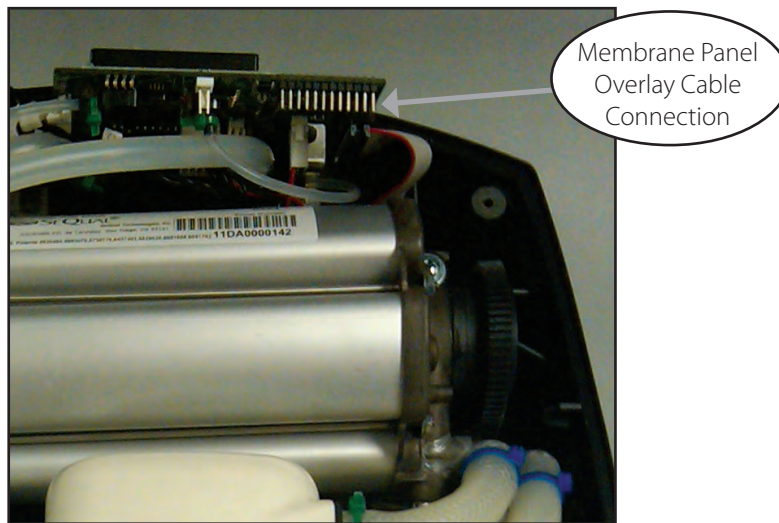

Figure 14: Removing the Membrane Panel Overlay Ribbon Cable.

7. Disconnect the silicone tube from the oxygen outlet tube at the top of the cover. First cut the cable tie, then pull the silicone tube off the oxygen outlet tube.

NOTE:	Always cut the heads of cable ties to avoid damaging the tubing.
--------------	--

CAUTION	Avoid possible eye injury by wearing protective eyewear or shielding the eyes from possible flying debris.
	

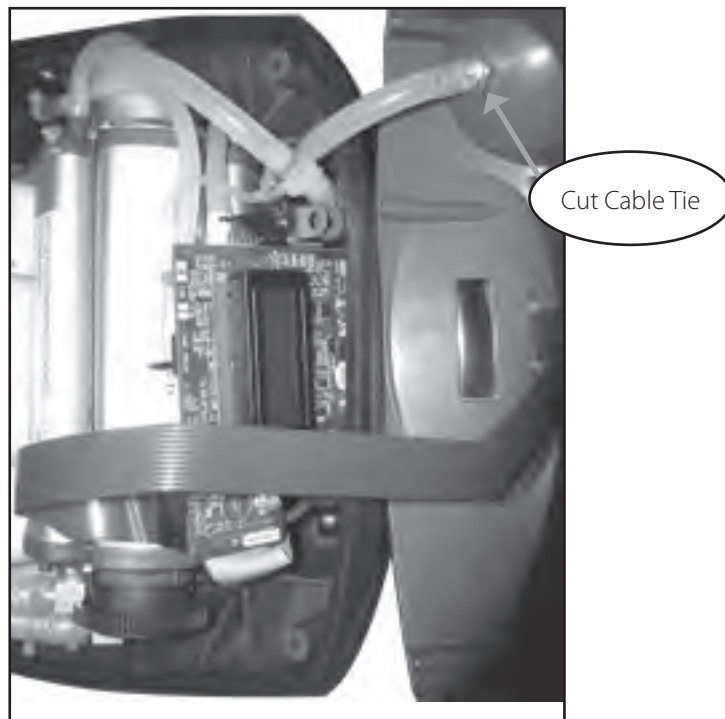

Figure 15: Disconnecting the Oxygen Outlet Tube

8. Lay the front panel away from Eclipse. Inspect PEM Nut anchors in the front cover assembly. Perform necessary maintenance.

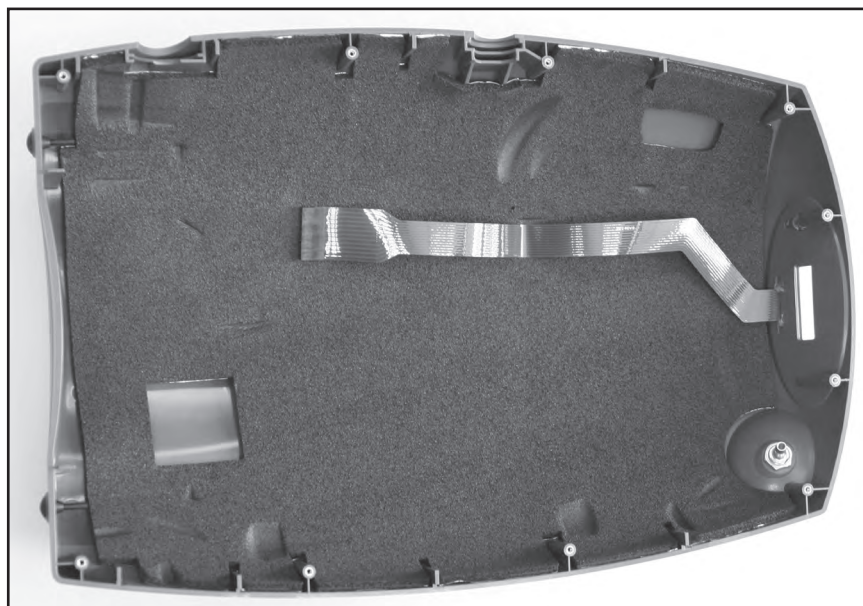



Figure 16: Front Cover Removal

Once the cover has been removed, the procedures listed in this section may be performed.

REMOVE AND REPLACE 9 VOLT BATTERY

Replace the 9-volt battery when the unit beeps three times at the end of power-on self-test, when voltage is less than 7.0 Volts, or during annual PM. To replace the 9-volt battery, follow these steps:

WARNING:	Disconnect power supplies and remove Power Cartridge before removing the unit cover. Do not touch exposed circuits during maintenance without ESD protection.
	

1. Remove the Eclipse front cover assembly.
2. Lift the battery out of the compartment located at the bottom right corner of the unit.

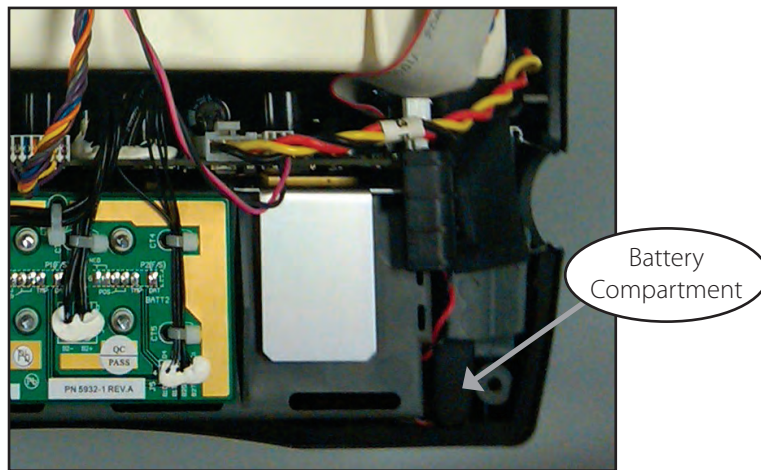

Figure 17: Removing the 9-volt Battery

3. Disconnect the 9-volt battery harness.
4. Remove and replace the 9-volt battery.



5. Reconnect the battery harness. Ensure that the terminals are aligned correctly.
6. Place the battery back into the compartment.
7. Install battery foam pad if necessary.

REMOVE AND REPLACE HEPA FILTER (Internal and External Filters)

Replace the HEPA filter annually, or more often as needed. To replace the HEPA filter, follow these steps.

WARNING:	<p>DO NOT use any petroleum based or other lubricants. A spontaneous and violent ignition may occur if oil, grease or other petroleum substances come into contact with oxygen under pressure. Keep these substances away from the oxygen system, tubing and connections and any other oxygen source.</p>
	
NOTE:	<p>Always cut the heads of cable ties to avoid damaging the tubing.</p>

External Filters (E1, E2, E2 Plus, and Early E3s)

1. Cut the three cable ties on the silicone tubes attached to the HEPA filter.

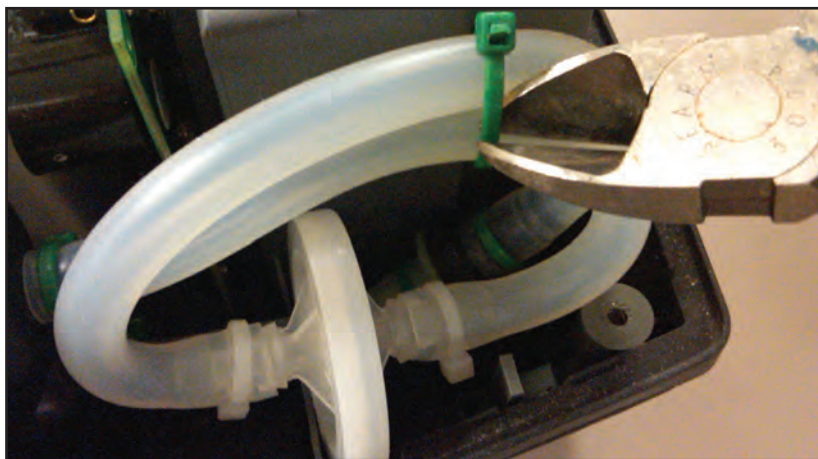

Figure 19: Removing the HEPA Filter.

2. Disconnect both tubes from the filter hose barbs.



Figure 20: Disconnecting the HEPA Filter.

3. Remove and replace the filter.

4. Reconnect silicone tubes to the filter. Verify flow direction is correct. Ensure that the feed tubes are not blocked, crimped or kinked upon completion of the installation or the unit will alarm for no/low oxygen flow after the warm-up cycle is complete. Route tubing as shown in Figure 22 below. Place HEPA filter into slot in case.

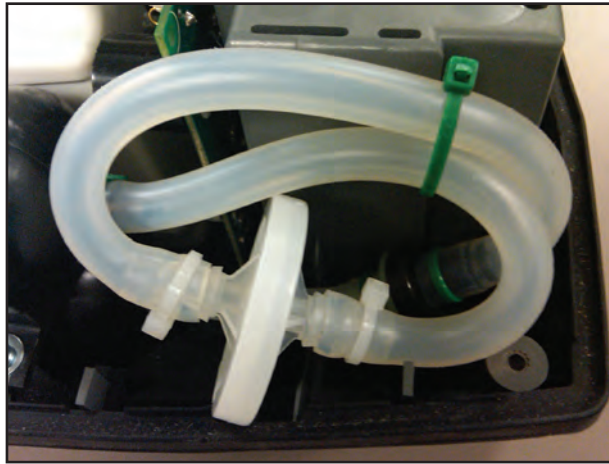



Figure 21: Installing the HEPA Filter.

NOTE:	Route tubing as shown in Figure 22. Install cable ties loosely as shown.
--------------	--

5. Re-install cable ties on silicone tubes.

CAUTION	Once the silicone tubes are disconnected from the HEPA filter the oxygen circuit is exposed to the atmosphere. Replace and reconnect the filter <u>immediately</u> in order to minimize exposure to debris and humidity which may result in ATF Module damage.
	

Internal Filters (Newer E3s)

HEPA Filter replacement SN: 11F06100456 and above:

1. Cut cable tie and Disconnect the tubing at the top of the filter carriage.



Figure 22: Tubing on Filter Carriage.

2. Unscrew the wing nut that hold the HEPA filter.

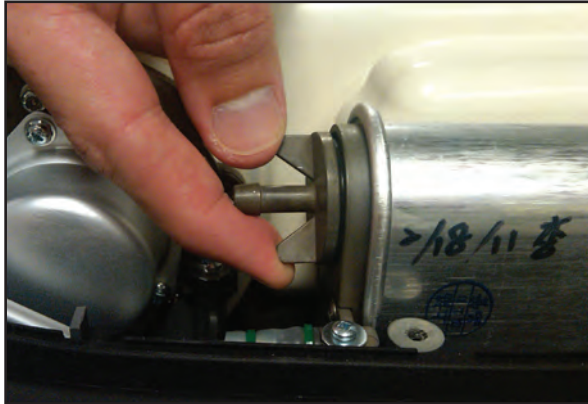

Figure 23: Wing Nut.

3. Unscrew the Clear HEPA filter and discard Filter & small O-Ring.



Figure 24: Unscrewing the HEPA Filter.

4. Install the new small O-ring and HEPA filter.



Figure 25 Installing the new HEPA Filter.

5. Locate the large O-ring on the product tank, replace it with the new large O-Ring included in the PM kit (5022-SEQ). Screw the new HEPA filter into the carriage holder (wing nut topped housing). Insert and screw the new HEPA filter (wing nut topped housing) into the Carriage holder (product tank) and finger snug in place (do not over-tighten). Re-attach Tubing and secure with a cable tie.

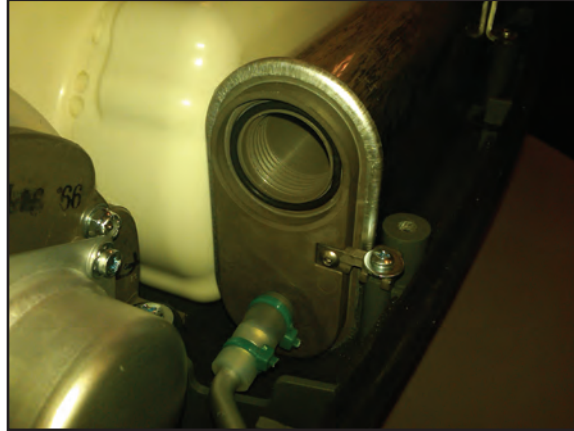



Figure 26 O-Ring.

REMOVE AND REPLACE THE COMPRESSOR INTAKE FILTER

Replace the compressor intake filter annually, or more often as needed. The compressor intake filter may become clogged depending upon the amount of contaminants in the air (smoke, dust, dirt, pollen, etc.) and may need to be changed more frequently. The most common cause of low concentration and eventual system failure is a dirty or clogged compressor inlet filter. Environmental conditions usually determine the effective life of a filter.

CAUTION	Operating the Eclipse with a clogged compressor intake filter may reduce performance and lead to system damage or premature failure.
	

NOTE:	Always cut the heads of cable ties to avoid damaging the tubing.
--------------	--

To replace the compressor intake filter, follow these steps:

1. Cut the cable tie on the silicone tubes attached to the compressor intake filter.



Figure 27: Removing the Compressor Intake Filter.

2. Remove the silicone tubes attached to each end of the filter body.
3. Install a new filter by pushing each tube completely over the barb on the filter body. Verify flow direction is correct.
4. Reconnect silicone tubes to the filter. Ensure that the feed tubes are not blocked, crimped or kinked upon completion of the installation or the unit will alarm for low oxygen purity after the warm-up cycle is complete.

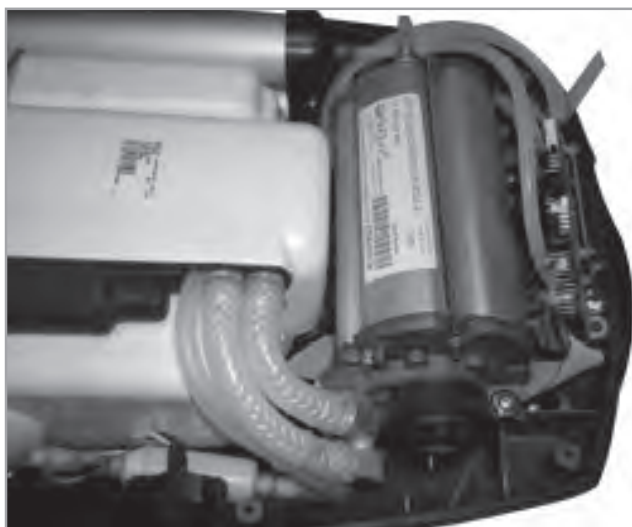

Figure 28: Installing the Compressor Intake Filter.

5. Re-install two cable ties on silicone tubes.

After replacing the Compressor Intake Filter, check the following:

- Verify proper seating of the filter in the Eclipse. The arrow on the filter body should point toward the 9-volt battery.
- Ensure that the inlet tube is inserted securely into its hole in the compressor box and is not pinched.

After filter is replaced and unit cover reinstalled, proper functionality should be checked by following the Test Procedures described in this manual.

REINSTALLING OR REPLACING THE UNIT COVER

Chart-SeQual recommends providers have EDAT (PN 5535-SEQ), or a spare Control Panel (PN SP4225-SEQ) that can be attached to the unit, and the unit run for a minimum of 20 minutes prior to re-installing the cover to check for a smooth and quiet calibration to be replaced by operation.

To re-install the cover, follow the steps using the reverse order. Ensure that the Membrane Panel Overlay cable plug is correctly lined up with circuit board connection and that there are no twists in the ribbon cable.

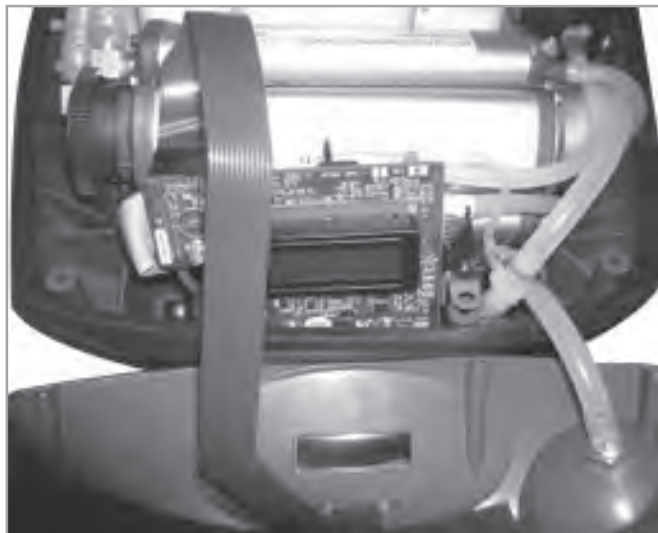

Figure 29: Membrane Panel Ribbon Cable Installation.

Align Front Cover over Control Board and then gently position front cover. Verify that the black rubber gasket (channel seal) and strain relief are aligned and fit properly. Do not over tighten cover screws (5 in. lbs. at maximum).

NOTE:	After the cover has been reinstalled, but before installing screws on the cover, re-connect power and start unit. Let the unit run for 20-30 minutes.
NOTE:	Whenever the cover of the Eclipse is removed, proper functionality should be checked by following the Test Procedure described next.

TEST PROCEDURES

ECLIPSE PURITY AND FLOW RATE TEST PROCEDURE - PREFERRED METHOD

It is recommended that the Eclipse be tested for oxygen concentration and flow performance. The SeQual recommended test setup is shown on the following diagram. Oxygen monitors may or may not have an internal pump to draw samples of oxygen to be measured. Placement of the oxygen monitor in the test setup depends whether they have an internal pump. Only one oxygen monitor is needed. An oxygen monitor such as Salter Labs' PRO₂ Check Elite[®] or equivalent may be used.

- Connect the circuit per the diagram shown below.
- Turn the concentrator on and set the target flow on the Eclipse to 3 LPM continuous flow.
- Allow the Eclipse to stabilize (can take up to 10 minutes).
- Verify the O₂ concentration and O₂ flow rate are within specification (shown in Table 1).

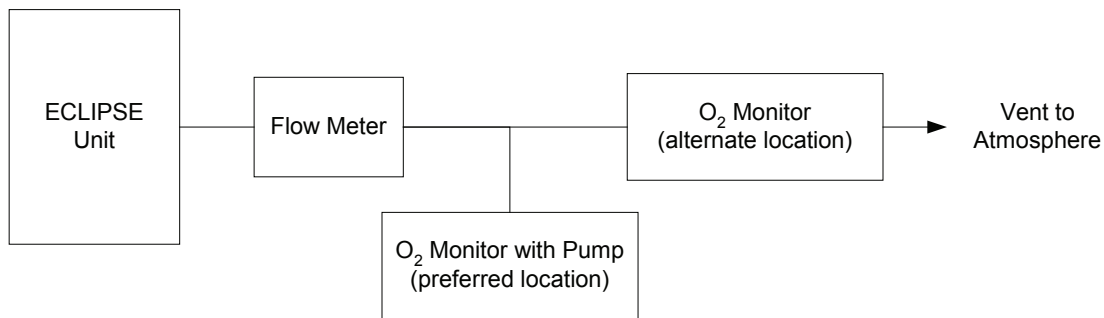

Figure 30: SeQual Recommended Test Setup to verify performance of Oxygen Concentrator

PURITY AND FLOW RATE TEST PROCEDURE-ALTERNATE METHOD

Attach a calibrated oxygen monitor to the oxygen outlet port in accordance with oxygen monitor manufacturer's recommendations.

NOTE:	Some sensing equipment may restrict the actual flow rate and provide inaccurate concentration readings. If testing is performed with the oxygen monitor in the alternate location pictured above, ensure that the oxygen monitor does not significantly restrict oxygen flow.
--------------	---

ASSEMBLY AND ALARM VERIFICATION TESTS

To ensure proper assembly and functionality of the Eclipse after it has been reassembled, the following steps should be followed.

1. Install the Power Cartridge into the Power Cartridge compartment of the Eclipse. Plug the AC Power Supply into the wall outlet and connect it to the External Power Connector of the Eclipse.
2. Press the ON button and set the Eclipse to 2 LPM. At initial start-up Eclipse units light the Green, Yellow and Red LED's accompanied by a beep. As concentration increases to ~70%, the Red LED turns off and the Yellow and Green remain on. When the concentration reaches normal operating range (above 85%), the Yellow LED will turn off. The Green LED will stay lit indicating normal operation. Table 3 shows the normal start-up operating conditions for Eclipse Oxygen Systems. If LED is not green within 7 minutes there may be a problem with the Eclipse.

Green Indicator	Yellow Indicator	Red Indicator	Audible Alarm	Alarm code	Operating Condition
Off	Off	Blinking	Beeps	004	Purity < 70%
Off	Blinking	Off	Off	008	Purity between 70% and 85%
On	Off	Off	Off	000	Normal Operating Condition

3. Verify that the Power Cartridge is charging as indicated by the Power Cartridge Status Gauge is moving in waterfall fashion (scrolling from bottom to top). If the Power Cartridge Status Gauge is not moving, verify that the Power Cartridge is properly engaged.
4. Check the Control Panel by pressing each of the Increase/Decrease, Pulse Dose Mode and No Smoking buttons and observe that the Eclipse buttons function normally.
5. Press the Delivery Mode button and set the Eclipse to the patient's normal Pulse Dose setting. Confirm that without breathing from the unit, after 15 seconds of no breath detected, the system changes automatically to Continuous Flow Mode. The green Delivery Mode light is blinking fast, indicating the system is delivering a Continuous Flow. After another 15 seconds, the system stops delivering Continuous Flow and waits 15 seconds trying to detect a breath. The cycle continues until a breath is detected.
6. After 5 minutes of operation, block the Cannula Fitting Outlet with your finger for 2 minutes and confirm that the visual and audible alarm occurs. Unblock the Cannula Outlet Port and let it stabilize until the alarm stops.
7. Disconnect the AC Power Supply and allow the Eclipse to run for about one minute. Set the Eclipse to the patient's normal Continuous Mode setting. Confirm that the Power Cartridge Status Gauge is illuminated and External Power Present Indicator is off.
8. Remove the Power Cartridge and verify that the Eclipse alarms and red Alarm Indicator is flashing and the alarm sounds. After about 5 seconds, re-install the Power Cartridge and connect the AC Adapter and observe that the Eclipse automatically restarts. Confirm that the External Power Present Indicator is illuminated.
9. Turn off Eclipse and unplug the AC Power Supply.
10. Record results, initial and date the Service and Maintenance Record.
11. EDAT may be utilized to record Eclipse device status and dates of service.

RECORD HOURS OF OPERATION AND SOFTWARE VERSION

To help maintain the Eclipse, you may obtain the Total Hours of Operation and software version numbers for the Control Board and the Power Manager Systems by following the steps below.

- If connected to the AC or DC Power Supplies, press the "No Smoking" icon on the control panel and advance to the following display mode for each time the icon is depressed:

- Alarm Code (ALRM) - Displays most recent alarm code. Additional alarm codes will also be displayed, if present, by continuing to press the + key.
- Pulse Sensitivity (PS)
- Hours of Operation (HRS)
- 9-volt Battery Status (9V)
- Rise Time (BOL)
- Control Board Software Revision
- Power Manager Software Revision

- If external power is not available and the power cartridge is installed, start by pressing the ON/OFF key for 1 second.

- If no key press is sensed within 5 seconds, the Eclipse will drop out of Provider Mode.

Data Output Form Example

Alarm Code	
Pulse Sensitivity	
Hours of Operation	
9-Volt Battery Status (Volts)	
Rise Time	
Control Board Software Revision	
Power Manager Board Software Revision	

Log the Results

NOTE:	The display accrues to "99,999.9" hours, then rolls over to "00,000".
--------------	---

ELECTRICAL SAFETY TEST

This is required only for the Eclipse 3 Oxygen System, PN 5701-SEQ that utilizes the Hospital Grade Power Cord.

To test the basic electrical safety of the Eclipse AC Power Supply, SeQual recommends using an LKG-601 Electrical Safety Analyzer (Netech Corporation, Hicksville, NY) or equivalent to verify that the current leakage to ground is within appropriate limits.

1. Plug the AC Power Supply into the electrical safety analyzer. Disconnect the AC Power Supply from the Eclipse unit.
2. Plug the electrical safety analyzer into a wall outlet.
3. Follow the analyzer manufacturer's instructions for measuring both the forward and reverse earth leakage current only. Verify that forward and reverse-current leakage to ground is $\leq 250 \mu\text{A}$ (100/115VAC applications) and $\leq 500 \mu\text{A}$ (220/240VAC applications).
4. Disconnect the AC Power Supply from the electrical safety analyzer.
5. If the AC Power Supply measures leakage current greater than the criteria in step 3, please return it to SeQual for service.
6. EDAT may be utilized to record Eclipse device status and dates of service.

CLEANING THE ECLIPSE

Clean inside the unit, as needed, using a small vacuum cleaner or brush to remove any accumulation of dust or debris prior to attaching the covers. After reinstalling the cover, verify that the rubber gasket is installed correctly.

Use mild detergent solution to clean the cabinet, Control Panel and power supplies. Turn OFF the Eclipse and disconnect from AC or DC power before any cleaning or disinfection activity. **DO NOT** spray the cabinet Control Panel or power supplies. Use a damp (not soaking wet) cloth or sponge. Spray the cloth or sponge with a mild detergent solution to clean the cabinet and power supplies. To disinfect the Eclipse, use Lysol[®] Brand II disinfectant. Proceed as directed by the manufacturer.

WARNING:	<p>Unplug Power Cords, AC or DC Power Supplies before cleaning the exterior cabinet. DO NOT use denatured alcohol or apply liquid spray or aerosol cleaners.</p>
	

PROVIDER SERVICE AND MAINTENANCE RECORD

Whenever maintenance or service is performed on an Eclipse unit, an entry should be made in the service log for that concentrator or recorded in accordance with your company’s standard procedure. Whenever the case of the Eclipse is opened, the flow rate, purity, and alarm status should be verified per the Test Procedures in this manual.

EDAT may be utilized to record Eclipse device status and dates of service.

NOTE: Use the “Save As” function under the “File” section and save the file as the SN and/or the date serviced (example: 08D0110xxxx 08012000).

Eclipse Serial Number _____							
Date	Hour meter Reading	Initials	Service Performed	System Checkout			Comments
				Purity	Flow	Alarms	

Table 13: Sample Eclipse maintenance record

SHIPPING AND TRANSPORTING THE ECLIPSE

When shipping the Eclipse use original packaging, if possible. Always remove the Power Cartridge and cart from the Eclipse prior to shipping.

If original packaging material is available repack the Eclipse, Power Cartridge, cart and power supplies in the designated packaging areas.

If original packaging material is not available, then place the Eclipse in a plastic bag and surround the concentrator with a minimum of two inches of soft foam packing material or bubble wrap. Wrap each accessory in a similar manner. Place the Eclipse and accessories in an appropriate cardboard box for shipping.

WARNING:	DO NOT expose the Eclipse to water. The Eclipse enclosure does not provide protection against the harmful effects of liquid ingress. Electrical shock or damage to the unit may result.
	

When the Eclipse must be transported in a delivery vehicle, simply secure the Eclipse and its accessories to prevent damage. Do not expose the device to extreme heat, cold, or humidity.

STORING THE ECLIPSE

Heat and humidity may degrade performance or severely damage the Eclipse. Store the device in a cool, dry, protected area away from high temperatures, moisture and humidity. Remove the Power Cartridge when storing the device.

The Eclipse must be turned on and run for 2 hours each month to ensure proper operation performance.

Tip: Running the power cartridge down completely and recharging it will provide two different features for the Eclipse:

1. Ensures the battery cartridge is calibrated
2. Running the Eclipse between uses while in storage allows the user to know if service may be needed prior to needing the device.

DISCARDING

Power Cartridge Disposal: The Power Cartridge can be recycled and should not be thrown into the trash. Contact the local city or town offices for instructions on proper disposal of the Power Cartridge. Alternately, Chart SeQual may be contacted for the Power Cartridge disposal.

Eclipse Oxygen System Disposal: Local environmental laws may prohibit disposal of electrical and/ or electronic equipment such as the Eclipse, AC Power Supply or the DC Power Supply. Contact the local city or town offices for instructions on proper disposal of electrical or electronic equipment. Alternately, Chart SeQual may be contacted for disposal information.

Troubleshooting, Service, and Repair Procedures

CAUTION



The Eclipse contains electrostatic sensitive components. Do not open or handle except at a static free workstation. Do not remove cover without ESD protection.



NOTE:

To adequately troubleshoot and repair the product in the field, EDAT is recommended. Eclipse Data Acquisition Tool (EDAT) PN 5535-SEQ

SYSTEM TROUBLESHOOTING AND ALARMS

PROVIDER TROUBLESHOOTING TABLE **DO NOT IGNORE ALARMS.**

Symptom	Probable Cause	Remedy
On Start Up (first 5 seconds) - unit beeps 3 times	The 9V battery (internal to the Eclipse) is low	Replace 9V battery/Perform Annual Preventive Maintenance (5022-SEQ)
On Start Up (first 5 seconds) - unit does not beep at all	The 9V battery (internal to the Eclipse) is below specification	Replace 9V battery/Perform Annual Preventive Maintenance (5022-SEQ)

YELLOW LIGHT		
Symptom	Probable Cause	Remedy
Operating Any Power Source: Yellow Light is "blinking" (Low O2 production 85 - 70%) Alarm is silent Press NO SMOKING button for Diagnostic Code "ALRM=008"	Restricted Air Flow through cabinet inlet filter	Perform Annual Preventive Maintenance (5022-SEQ); if issue remains call Chart TS for service
	Blocked Air Flow to cabinet inlet filter	Ensure the Eclipse has adequate air flow around the device (6" around the device) - turn the device around in the car(exhaust facing to the middle of the car)
	Restricted Air Flow through Internal Filters	Perform Annual Preventive Maintenance (5022-SEQ); if issue remains call Chart TS for service
	Pulse Mode: Out Breathing the Eclipse exceeding Breaths Per Minute for that Pulse setting	Patient's breathing is too fast for Breath Rate to operate within that Pulse setting's specifications(See table for max BR in Pulse.). Can be verified using the EDAT software program (PN: 5535-SEQ)
Operating on Battery Power: Yellow Light is "blinking" and unit is "beeping" Press NO SMOKING button for Diagnostic Code "ALRM=010"	Low Battery: Running on Battery power, not plugged into external power	During Battery use, the Battery the indicator will decrease until a Low Battery condition is met. Change with a fresh battery.
	Loss of External Power: Plugged in to external power but running on Internal Battery	Verify the Power Verification Indicators (Green LEDs) on the power supply and the membrane panel are ON
	Battery is out of calibration	Unplug the Eclipse from EXT power, Run the battery all the way down until the Eclipse shuts down and alarms, Plug it in to AC power and allow to recharge fully. Replace battery, if it does not come back within specification.
Any Power Source: Yellow Light is "Blinking" and Unit is "beeping" (Low or No Oxygen Flow) Press NO SMOKING button for Diagnostic Code "ALRM=020"	Eclipse is ON . . . Filter Blocked	Perform Annual Preventive Maintenance (5022-SEQ), if issue remains call Chart TS for service.
	Humidifier attached?	*Check/Clean Humidifier and tubing *Remove Humidifier if in Pulse Mode
	Tubing is not properly connected or kinked	Check Tubing, Humidifier and Cannula for blockage, and clean as needed
	Other	Contact Chart TS for service
On Battery Power: Yellow light is "On" and "Steady" - Alarm is silent Warm Battery Press NO SMOKING button for Diagnostic Code "ALRM=002"	Warm Battery Condition: The Battery's internal temperature has increased to a point above 113F (45C) degrees that will not allow the Battery to charge. When in use, above 140F (60C) the battery will flag the code 002, and shut down about 158F (70C).	Allow the Eclipse and Battery to Cool for 30 minutes Minimum. (Remove battery and store in a cool place, re-insert the battery.) Replace with a fresh cool Battery
	Shut Down due to overheating: the Eclipse displays a FAIL 92, FAIL 91	Reset Power to the Eclipse. (Remove Battery and External Power together, wait 30 minutes or until cool. Re-insert External power or re-insert the battery.) If condition remains contact Chart TS for service

RED LIGHT			
Symptom		Probable Cause	Remedy
During Operation: Red Light "Blinking" and "3 Beeps" (Low O2 condition - Less than 70%) Press NO SMOKING button for Diagnostic Code "ALRM=004"	BLINKING & BEEPING	Restricted Air Flow through cabinet inlet filter	Perform Annual Preventive Maintenance (5022-SEQ), if issue remains call Chart TS for service.
		Blocked air flow to cabinet inlet filter	Ensure the Eclipse has adequate air flow around the device (6" around the device) - turn the device around in the car(exhaust facing to the middle of the car)
		Restricted air flow through Internal Filters	Perform Annual Preventive Maintenance (5022-SEQ), if issue remains call Chart TS for service.
		Possible Blockage or Leak of air flow through internal components	Contact Chart TS for RMA service.
During Operation: Red Light "Constant" and alarms "constant tone" FAIL Condition Displayed "FAIL XX"	STEADY & CONSTANT ALARM	Unit has shut down and displays a FAIL XX code	May indicate a Power Loss Condition or Internal malfunction. *Remove all power (Ext power and Battery cartridge) from the Eclipse. *Wait 15 Seconds. *Re-Connect External AC power and listen for the External Power connection "3 second beep". Press the "ON" button and allow the Eclipse to come up to Green Light operation.
		Other	Contact Chart TS for RMA service
Eclipse Red Light and Alarms: Battery has become Too Hot. FAIL Condition Displayed "FAIL XX"	STEADY & CONSTANT ALARM	Battery is too Hot and will not operate the Eclipse; above 158°F (70°C)	*Remove the battery and allow to cool *Replace with a fresh cool battery.
		Eclipse Overheated, Display shows a FAIL 92, Fail 91, or FAIL A4	Allow the Eclipse to cool off (30 Minutes Minimum) below the internal temperature of 115 F - remove power, wait 15 seconds, plug back in to External Power only and restart the Eclipse. Install battery if needed.
		Other	Contact Chart TS for RMA service.

OTHER CONDITIONS			
Symptom		Probable Cause	Remedy
Pulse Mode: Green Pulse Mode Led is Steady then Flashing Press NO SMOKING button for Diagnostic Code "ALRM=200" (Eclipse is going from Pulse to Continuous every 15 seconds.)	STEADY THEN FLASHING	Not detecting a patient's breath Unit is in a Breath Search mode	Ensure Cannula Tubing is not more than 7ft (2.1m) in length. Ensure it is not kinked or disconnected.
			Ensure you are not using a Humidifier - check for water block in cannula
			Ensure Patient is breathing through their nostrils. Patient may be a mouth breather, not allowing enough negative pressure to trigger the device's bolus volume.
		Provider to properly set the Pulse Sensitivity settings for their client. (menu: PS=XX)	
		Other	Contact Chart TS for RMA service

OTHER CONDITIONS (CONTINUED)			
<p>Battery Power: My Battery is not Lasting the time it used to... NOTE: Battery times will decrease with higher bolus size, breath rate, ambient temperature, Battery age and use over time.</p>	VISUAL	Battery End of Life: May have exceeded the life expectancy of 500 full Charge/ Discharge cycles.	Discharge it fully, recharge it fully, then measure the length of discharge to within 20% of new specification. Replace if higher that 20% loss of charge.
		Calibration: The Eclipse Battery may be out of calibration	*Unplug the Eclipse from external *Allow Eclipse to operate until the Red Light comes on and alarm sounds constant(Loss or Power) *Plug in to External AC power and allow to recharge
		The Eclipse display may display (****) stars in place of the battery display	Indicates a loss of communication from the battery. Change the Battery with a fresh one. If the issue remains, contact your home oxygen provider for service.
		A power interruption that causes The Eclipse display to read "FAIL 81", or "FAIL 95" *Red Light and constant tone alert	This error code may indicate a Power Loss and reconnection. *Remove all power(Ext power and Battery cartridge) from the Eclipse. *Wait 15 Seconds. *Re-Connect External AC power and listen for the External Power connection "3 second beep". Press the "ON" button and allow the Eclipse to come up to Green Light operation.
		Other	Contact Chart TS for RMA service
<p>Eclipse runs on Battery power when plugged into external power (AC or DC) Unit will beep for loss of external power</p>	ONE BEEP ONLY	AC power is loose or not connected	Plug device directly into known good AC outlet, extension cord and computer strips are not recommended
		DC power is loose or not connected	*Remove battery from the eclipse and ensure can operate the Eclipse un-interrupted on car power *Use power cartridge(s) if car does not have adequate power *Have outlet checked for proper current rating
		Unit runs the battery down when you don't expect it to?	*Unit may be plugged into external power but the power verification light is "not" on *Check outlet, check plug on power supply, check power plug on Eclipse
		Other	Contact Chart TS for RMA service
<p>Power Cartridge (Battery) status gauge no longer indicates fully charged</p>	VISUAL	Power Cartridge (battery) is partially/ completely discharged.	Plug device directly into known good AC outlet (verify a waterfaling [scrolling bottom to top] battery indicator)
		Power Cartridge (battery) is not seated properly in the Eclipse compartment.	*Reseat Power Cartridge in the Eclipse battery compartment *Ensure both locking pins are engaged [check for waterfaling (scrolling bottom to top) battery indicator if not fully charged]
		Power Cartridge (battery) out of Calibration.	Calibrate Battery: Unplug ext power turn unit on, allow to run until power loss (Red Light and constant tone alert), plug unit into AC power to charge (ensure indicator is waterfaling [Scrolling Bottom to top]).
		Power Cartridge (battery) is aging.	Typical average end of life is 500 charge/discharge cycles: Replace with a known good battery
		Other	Contact Chart TS for RMA service.

WARNING:	<p>WARNING: Do not modify this equipment without authorization of the manufacturer.</p>
	

ALARM CONDITIONS AND ALARM CODES

Use the table below to decode Eclipse alarm conditions. If other alarm codes are displayed by the Eclipse, contact Chart- SeQual Technical Service for assistance.

Note: The following table is intended as a guide for the provider, not the user.

CONDITION	ALARM CODE	ALARM DISPLAY	GREEN INDICATOR	YELLOW INDICATOR	RED INDICATOR	AUDIBLE ALARM	WHAT TO DO
"Warming Up. Please Wait."	004	O2 < 70%	ON	ON	ON	OFF	Wait. The system typically takes 3 – 5 minutes to reach specified performance.
"Warming Up. Please Wait."	008	O2 < 85%	ON	ON	OFF	OFF	Wait. The system typically takes 3 – 5 minutes to reach specified performance.
"3.0" (or flow setting)	000	NO ALARM	ON	OFF	OFF	OFF	Nothing. The system is operating properly at the specified flow rate.
"Low Power Cartridge"	010	LOW BAT	ON	Flashing	OFF	2 Beeps	Plug into external power or replace with a charged Power Cartridge.
"Warm Power Cartridge"	002	WARM BAT	ON	Flashing	OFF	1 Beep	Plug into external power or replace with a charged Power Cartridge.
"Low 9V Battery"	-	-	OFF	OFF	OFF	3 Beeps on POST	Replace the internal 9-volt battery.
"O ₂ Concentration < 85%"	008	O2 < 85%	OFF	Flashing	OFF	OFF	Perform Annual Filter PM Maintenance. If condition persists, service is required.
"O ₂ Concentration < 70%"	004	O2 < 70%	OFF	OFF	Flashing	3 Beeps	Perform Annual Filter PM Maintenance. If condition persists, service is required.
"Flow Rate Error / Blocked Flow"	020	FLOWRATE	OFF	Flashing	OFF	1 Beep	Check tubing and/or humidifier for obstruction. Check/clean air intake filter. If condition persists past 10 minutes, service is required.
"Cannot Charge Power Cartridge"	001	CHARGER	N/A	ON	OFF	OFF	Instruct patient to seek an external power source. Remove Power Cartridge and allow to cool to room temperature. If Power Cartridge malfunction persists, service is required.
"One Wire Communication Loss"	100	ONE WIRE	N/A	Flashing	OFF	1 Beep	Check battery connections.
"No Inspiration Detected" (in Pulse Mode only)	200	P <--> C	ON	OFF	OFF	OFF	If no inspiratory effort is detected after 15 seconds, the Eclipse will switch to Continuous Flow for 15 seconds, and continue this sequence until a breath is detected.
"Loss of External Power" (without charged Power Cartridge installed)	040	***** (flashing)	OFF	OFF	Flashing	ON for 5 min	Instruct patient to seek an alternative oxygen supply until external power is restored or install a charged Power Cartridge.
"System Fault"	080	FAIL XX	OFF	OFF	ON	ON 10 seconds then silent	Reset power, wait 20 seconds, reconnect power, restart device. Instruct patient to use back up oxygen supply. Service is required.

MALFUNCTION CODES

If a malfunction occurs in the Eclipse, the device will stop, the Red LED on the front panel will light and the buzzer will sound for 10 seconds and then silence. The LCD will display one of the following Malfunction Codes:

Malfunction	FAIL code	Recommended Action
Invalid RESET	FAIL 80	Check for secure communication cables, Verify functionality of PM and CS PCBs
I/O Port Failure	FAIL 81	Check for secure communication cables, Verify functionality of PM and CS PCBs
RAM Failure	FAIL 82	Check for secure communication cables, Verify functionality of PM and CS PCBs
FLASH Failure	FAIL 83	Check for secure communication cables, Verify functionality of PM and CS PCBs
EEPROM Failure	FAIL 84	Check for secure communication cables, Verify functionality of PM and CS PCBs
IPC Watchdog Timeout	FAIL 90	Check for secure communication cables, Verify functionality of PM and CS PCBs
Compressor Motor Too Hot	FAIL 91	Allow Eclipse to Cool for 30 Mintues, Check compressor fan functionality, Check to ensure vents are not obstructed, Verify functionality of the Compressor Assy
PCB Too Hot	FAIL 92	Allow Eclipse to cool for 30 Minutes, Verify functionality of PM fan, Check to ensure vents are not obstructed
Compressor Motor Stalled	FAIL 94	Check Compressor wires for damage, Verify functionality of PM PCB, Verify functionality of the Compressor Assy
Battery Communication Failure	FAIL 95	Verify functionality of the Battery Bridge PCB, Check Battery and Battery Bridge PCB for pin damage, Verify functionality of battery, Verify functionality of PM pcb
IPC Failure	FAIL A0	Verify functionality of PM PCB
Product Pressure Sensor Failure	FAIL A1	Verify functionality of CS PCB
Breath Pressure Sensor Failure	FAIL A2	Verify functionality of CS PCB
Ultrasonic Failure	FAIL A3	Verify functionality of CS PCB, Check for water intrusion from humidifier
Product Temperature Sensor Failure	FAIL A4	Verify functionality of DB9 cable harness, Verify functionality of CS PCB
Loss of Product Tank Pressure	FAIL A5	Check for leaking, cracked HEPA filter or damaged tubing, Verify ATF motor is turning
Purity Calibration Data Failure	FAIL A6	Check for leaking, cracked HEPA filter or damaged tubing, Verify functionality of CS PCB
Flow Calibration Data Failure	FAIL A7	Verify functionality of Proportional Valve, Verify functionality of CS PCB
Breath Sensitivity Data Failure	FAIL A8	Check for damaged tubing, Verify functionality of CS PCB
Hour of Operation Data Failure	FAIL A9	Verify functionality of CS PCB
Invalid Assembly Option	FAIL AA	Remove Power to Reset
Ambient Pressure Sensor Failure	FAIL AB	Verify functionality of CS PCB
Unidentified Failure	FAIL FF	Remove Power to Reset

Step 1: Remove all power sources; battery and external power. Wait 20 seconds. Reconnect power to the Eclipse. Turn the device to the ON position. If resolved, continue use.

Step 2: If unresolved, Call Chart T/S for assistance.

System Schematics and Diagrams

SIMPLIFIED BLOCK DIAGRAM

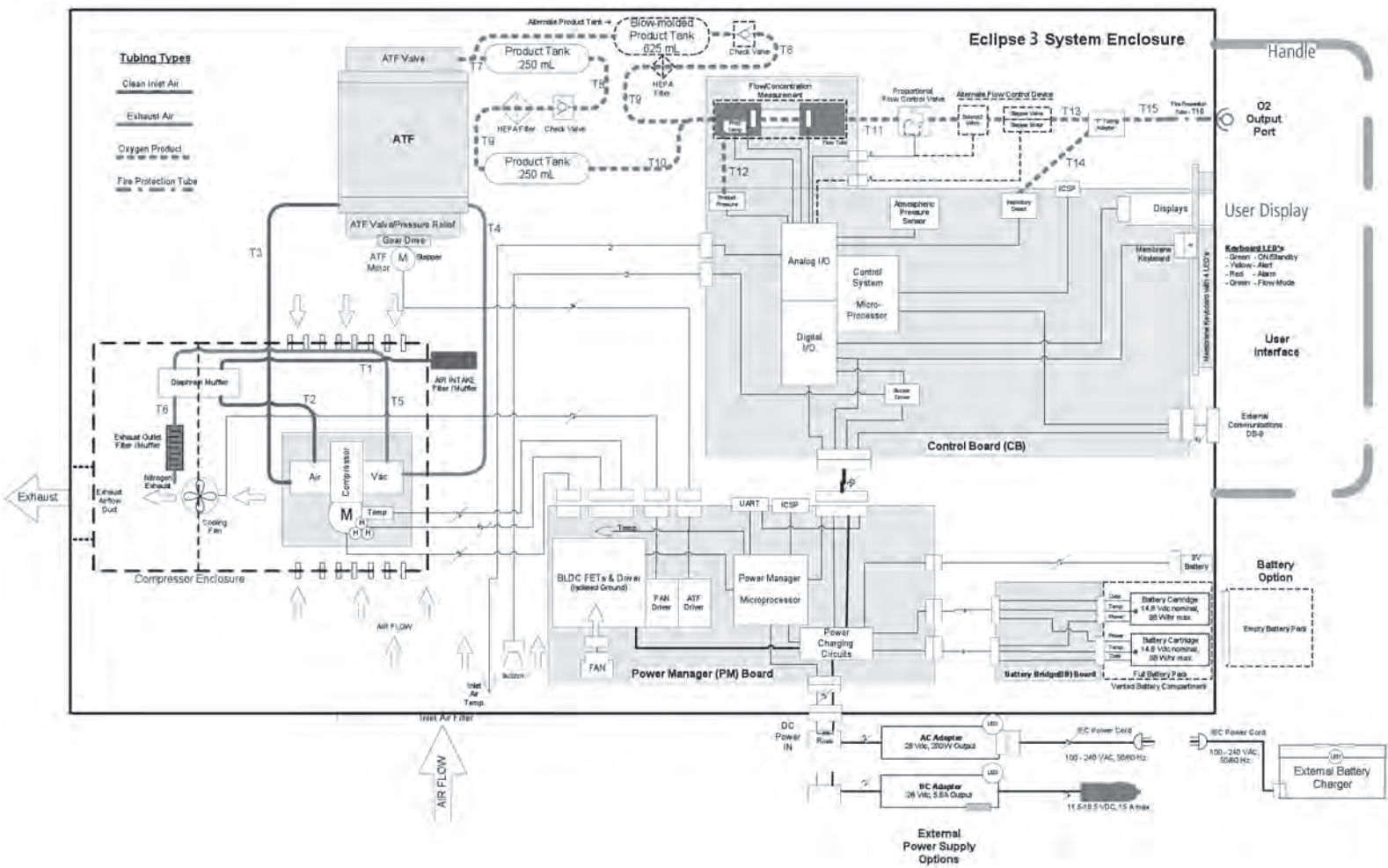

Figure 31: Eclipse 3 Oxygen System Simplified Block Diagram.

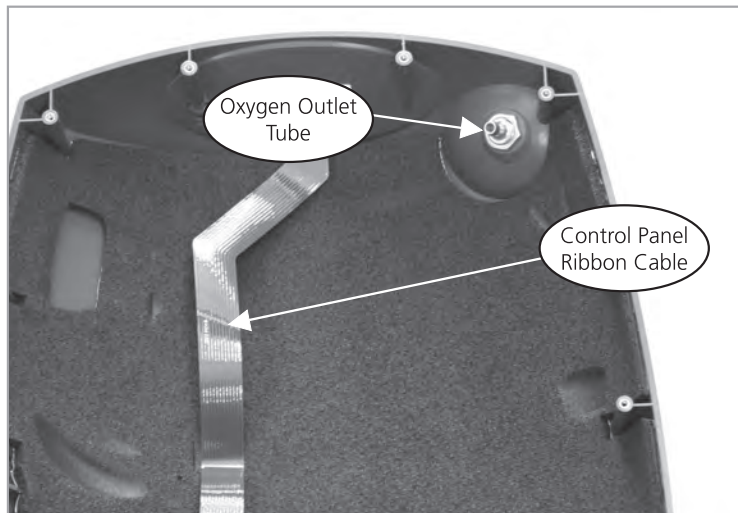

Figure 32: Top Case Components.

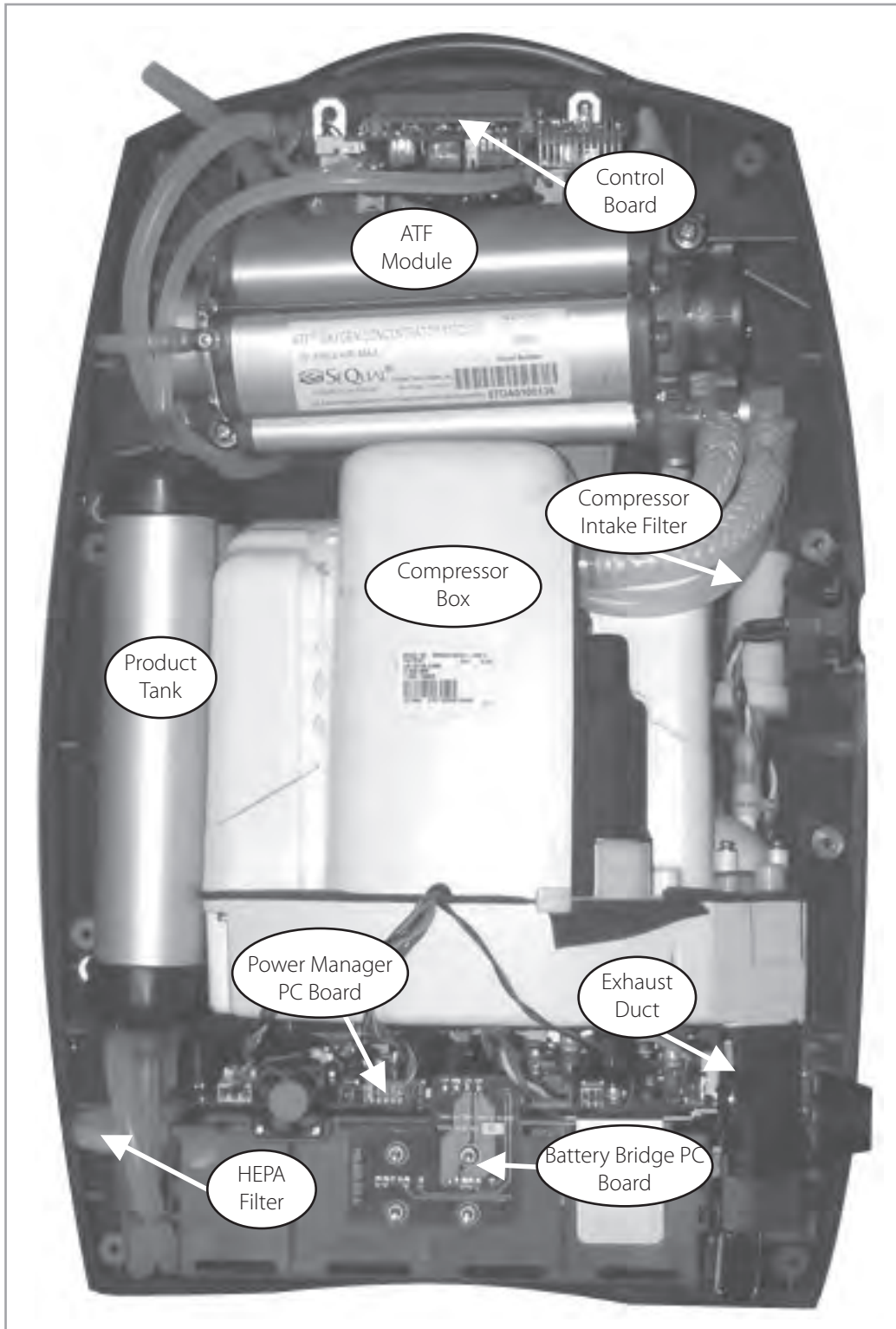

Figure 33: Bottom Case Components.

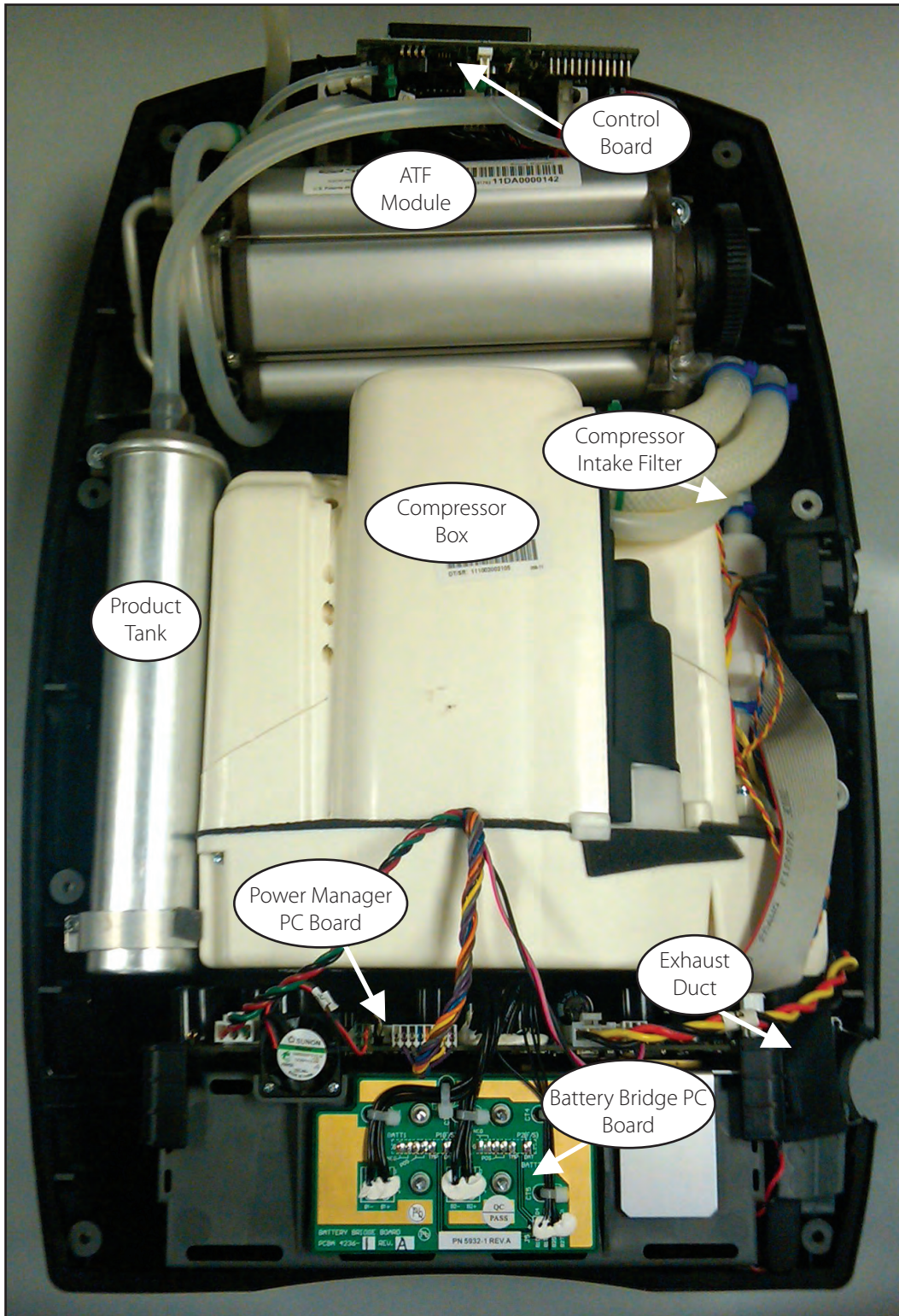

Figure 34: Bottom Case Components—Eclipse 3 Manufactured December 2011 and above

Oxygen Circuit

REMOVE AND REPLACE THE ATF MODULE

NOTE:

There are no serviceable parts inside the ATF Module. Do not attempt to disassemble or modify the ATF Module.

1. Remove the Unit Cover as described in the section Remove and Replace the Unit Cover.
2. Cut the green tie as shown below, and disconnect the silicone tube that goes into the product port of the ATF; this tube comes from the Product Tank.
3. Install port cap.

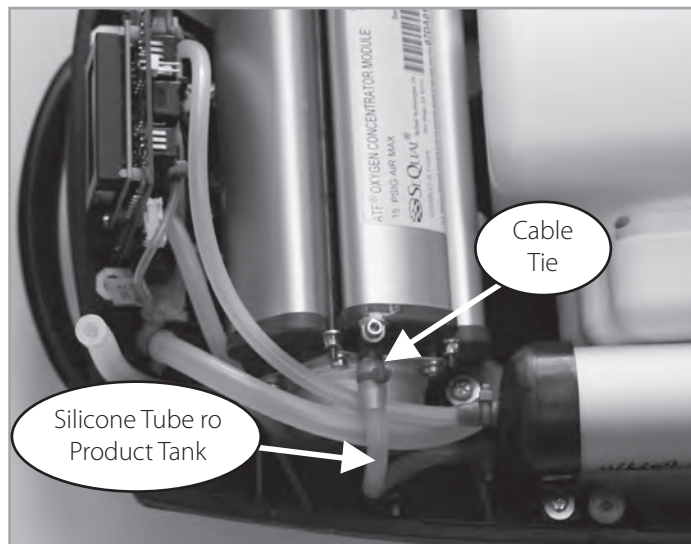

Figure 35: Removal of ATF Module Product Hose.

4. Cut the green cable tie that secures the silicone tube to the braid tube at shown below.

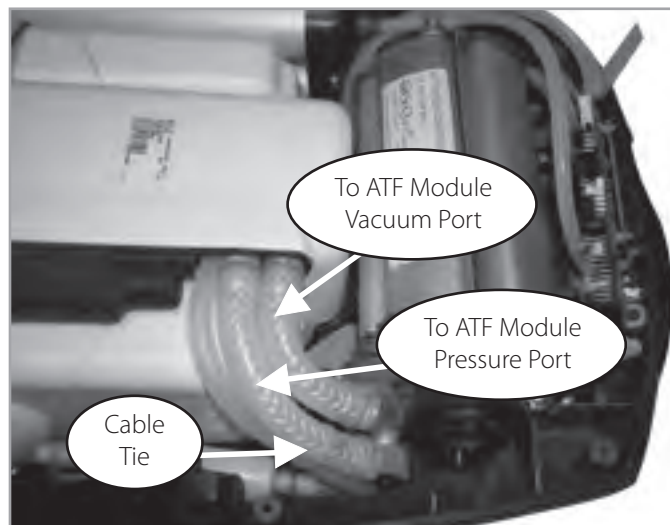

Figure 36: Removal of ATF Module Pressure and Vacuum Tubes.

5. Cut the green cable ties to the braided tubes that connect into the ATF pressure and vacuum ports as shown below. Disconnect the braided tubes.
 - 5a. Install port caps.
6. Unscrew the 3 screws (M4x16 Pan Head Machine Screw, P/N 6961-416) and remove the screws and washers (M4 Flat washer, P/N 6985-04) as shown below.

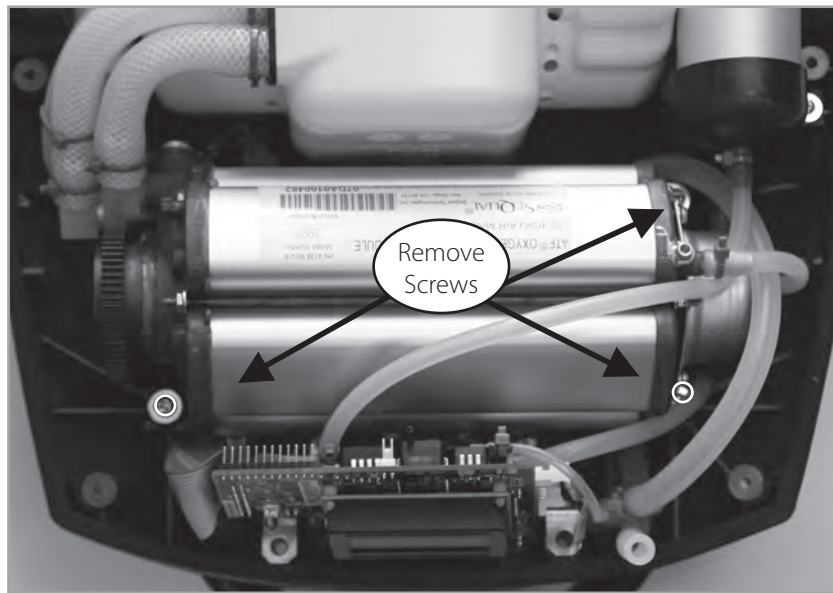

Figure 37: Remove ATF Module from Eclipse Case.

7. Lift the ATF. Take off the 3 grommets. Disconnect the wire harness from the gearbox of the ATF.
8. Remove the ATF.
9. Install 3 Grommets into the mounting slots on the ATF as shown below. Position the ATF into the bottom cover but DO NOT install the mounting screws yet. Route the 16" Silicone Tube under the ATF as shown on Figure 39 on next page.



Figure 38: ATF Module Grommet Installation

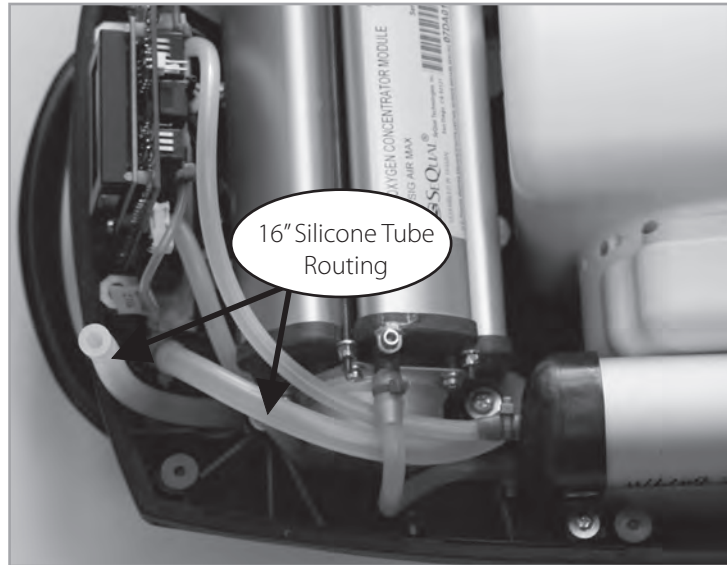



Figure 39: Tube Routing under ATF Module.

- Place the ATF in the Unit Case and remove the caps from the ATF Ports. Install the Braided Tubes into the ATF pressure and vacuum ports as shown on Figure 31. Do not use oil or grease if the tubing is difficult to install. Secure joints with Cable ties.

WARNING:	<p>DO NOT use any petroleum based or other lubricants. A spontaneous and violent ignition may occur if oil, grease or other petroleum substances come into contact with oxygen under pressure. Keep these substances away from the oxygen system, tubing and connections and any other oxygen source.</p>
	

NOTE:	Inspect all tubing before securing with a cable tie.
--------------	--

- Mount the ATF with 3 M4x16 screws and 3 washers as shown on Figure 32 on previous page. Apply Loctite[®] 425 Thread Locker on the threaded tips of the screws before installing. Tighten screws but DO NOT squash the grommets (2 in.lbs. maximum).

NOTE:	Over tightening may cause excess vibration.
--------------	---

CAUTION	<p>Remove caps on ATF ports ONLY before connecting the tubes. DO NOT leave the ports open unless ready to install the tubes. Also place the removed caps from the new ATF and place on the ports of the replaced ATF.</p>
	

12. Remove caps from ATF Module.
13. Connect the silicone tube from the Product Tank into the product port of the ATF and secure joints with cable ties as shown on Figure 30 on page 57.
14. Use cable tie to secure the silicone tube to the braid tube to ensure that there is NO kinking on the bend as shown on Figure 31 on page 57. Hand-tighten the cable tie. Inspect the tubing to ensure the tubing is not kinked.
15. Perform product test prior to installing cover and again after cover replacement.
16. Installation of the Unit Cover on the unit is described in the Remove and Replace of the Unit Cover.

REMOVE AND REPLACE THE PRODUCT TANK ASSEMBLY (PN 6138-SEQ) ECLIPSE 1, ECLIPSE 2, EARLY ECLIPSE 3

1. Remove the Unit Cover as described in the section Remove and Replace the Unit Cover.
2. Cut the 2 green cable ties that secure the silicone tubes to the top of the Product Tank as shown in Figure 35 below. Disconnect these two silicone tubes. Pinch the silicone tube coming from the ATF product port and secure with a cable tie as shown on Figure 36 on next page.

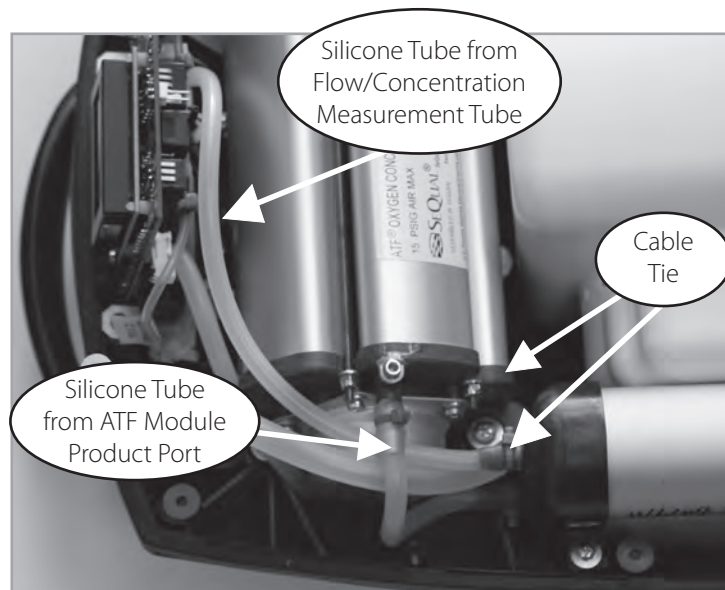

Figure 40: Product Tank inlet and Outlet Connections.

3. Unscrew the 2 screws (M3x10 Plastite Screw, P/N 6950-310) and remove the screws and washers (M3 Flat Washer, P/N 6950-03) as shown in Figure 41 shown below.

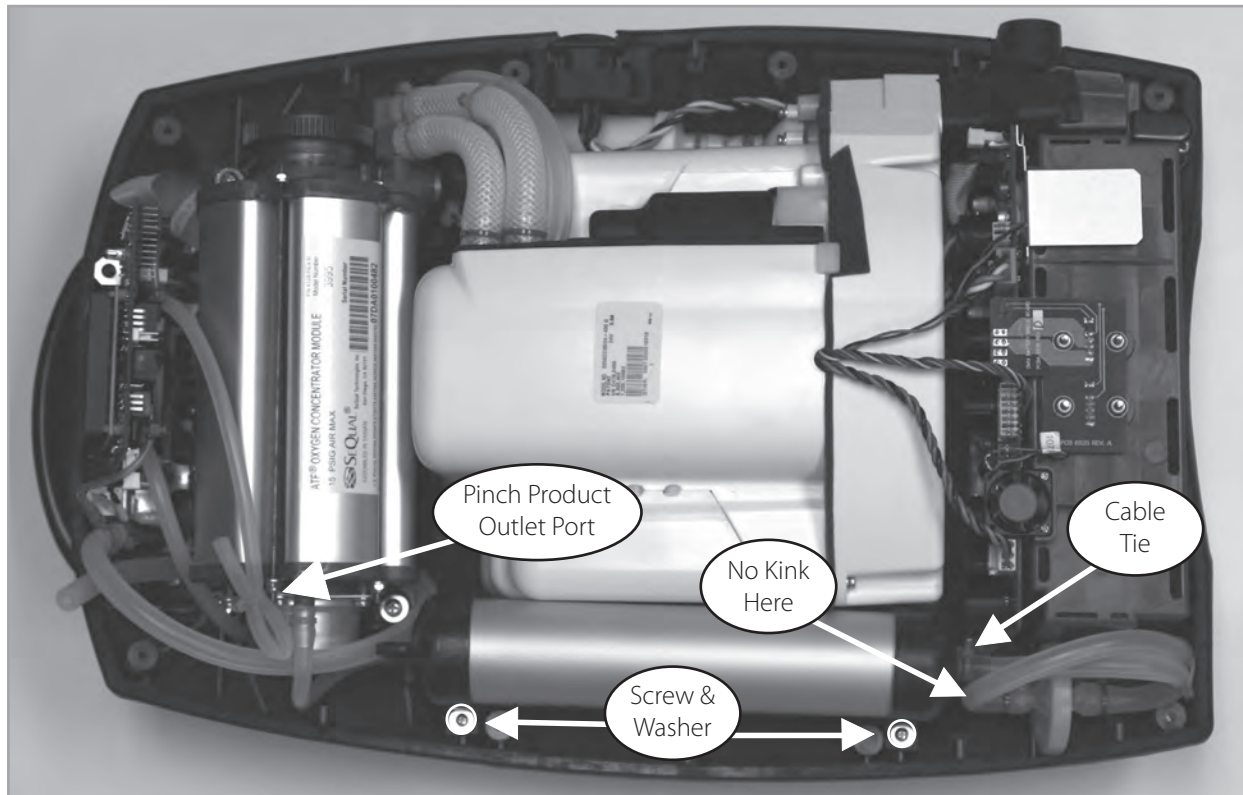

Figure 41: Product Tank Removal.

4. Remove the Product Tank.
5. Cut the 2 green cable ties that secure the silicone tubes to the bottom of the Product Tank as shown in Figure 40 on previous page. Disconnect these two silicone tubes.
6. To reinstall, secure the 2 silicone tubes coming from the HEPA filter to the bottom ports of the Product Tank. Orient the HEPA filter so the loop is above the filter as shown in Figure 41 above. Secure joints with cable ties. Inspect the tubing to ensure the tubing is not kinked.
7. Install the silicone tube that comes from the ATF product port to the bottom Product Tank as shown in Figure 40 on previous page. Secure with a cable tie. Inspect the tubing to ensure the tubing is not kinked.
8. Install the silicone tube that comes from the flow tube of the Control Board to the top product tank as shown in Figure 40 on previous page. Secure with a cable tie. Inspect the tubing to ensure the tubing is not kinked.
9. Install Product Tank with 2 screws and 2 flat washers into the Unit Case as shown in Figure 36 above.
10. Perform product test prior to installing cover and again after cover replacement.
11. Installation of the Unit Cover on the unit is described in the Remove and Replace of the Unit Cover.

ROUTING DIAGRAM FOR PNEUMATIC TUBING

Use the picture below as an aid to ensure proper routing of oxygen tubing in the Eclipse.

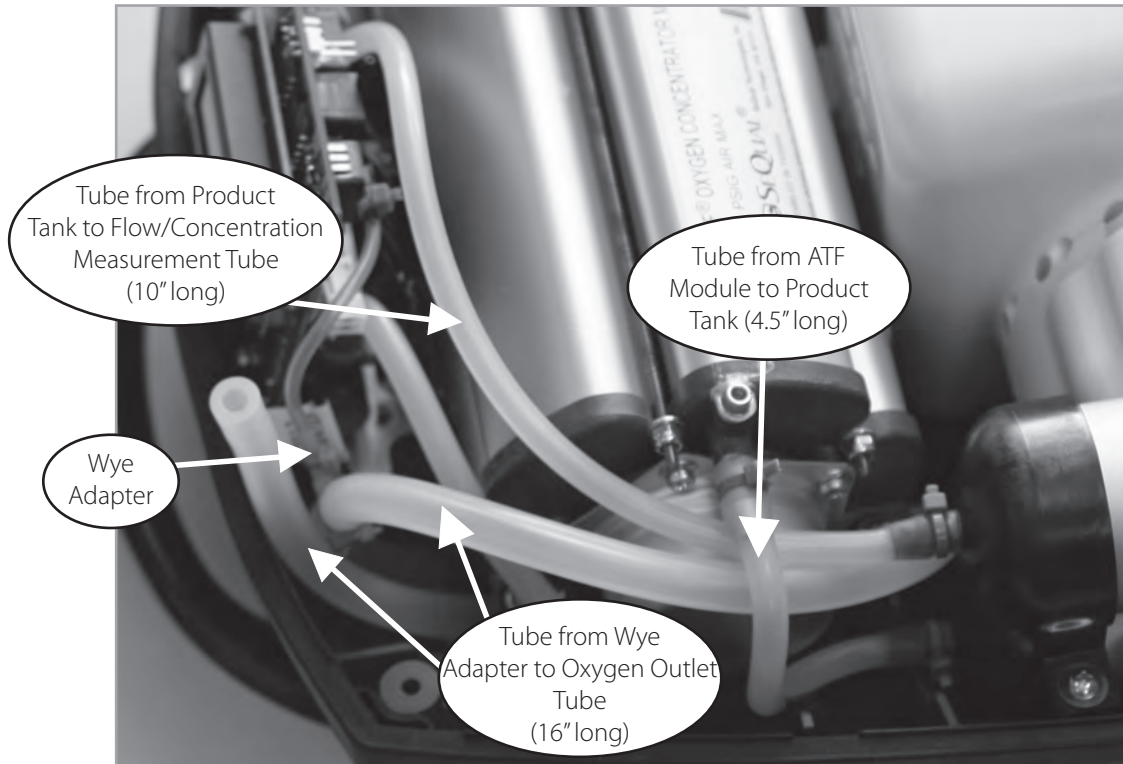

Figure 42: Oxygen Tubing Routing

REMOVE AND REPLACE THE PRODUCT TANK ASSEMBLY (PN 4378-SEQ) ECLIPSE 3-2011 IN SN 11F06100456 AND ABOVE

Situation# 1) If you are “upgrading” from a previous model Product Tank (PN1038-SEQ) you will need to let Tech Support know as the ATF output port is in a different location as it can be different between ATF models (PN: 3995 to PN: 5494). Output port has changed location. Then follow steps for Situation 1.

Situation# 2) If you are removing the Product Tank for a failure of one of its components then follow steps for Situation 3.

Situation# 3) If you are just replacing the HEPA filter then follow the steps in the PM section for Remove and Replace HEPA Filter.

Situation# 1: Removal of Old Style Product Tank(PN: 6138-SEQ)

- 1) Follow the steps to Removing the Unit Cover
- 2) Remove the Front Cover Assembly completely; outlet tubing and front membrane ribbon cable. Set aside.
- 3) Locate the Product Tank and cut the cable ties from the ATF to the product tank (Bottom), and O2 out from the outlet connector (Top). Remove tubing from ATF to lower product tank barb. See Figure 43.

Important: Cap off the ATF hose barb with a black hose barb cap.

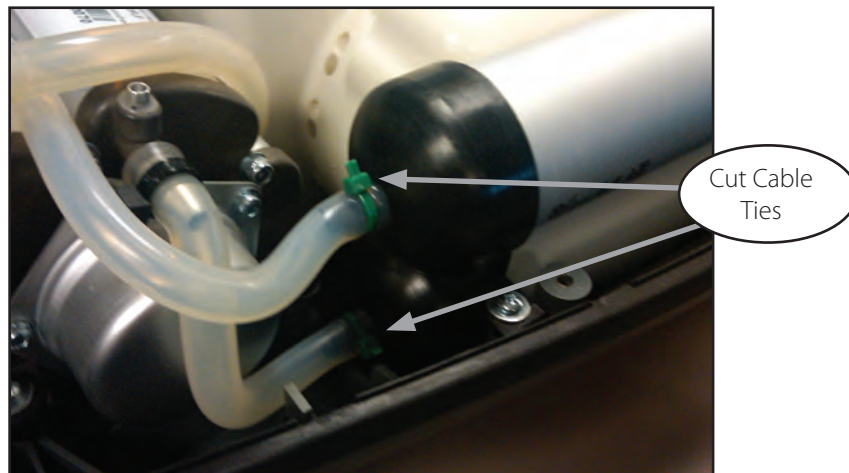

Figure 43: Cut Cable Ties

- 4) Locate the 2 screws that hold the securing straps and the product tank in place, remove the screws. Set aside for re-installation. Figure 44.

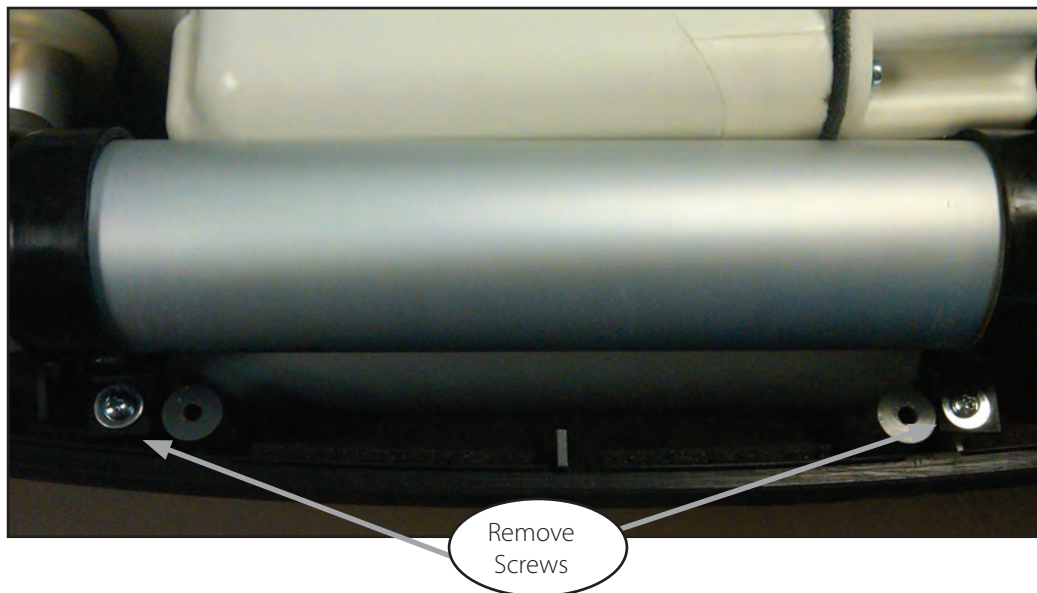

Figure 44: Remove Screws

- 5) Lift out the old product tank(PN: 6138-SEQ). Set aside for RMA return or scrap.

Install new Product Tank (PN: SP4378-SEQ or 4378-SEQ)

- 1) Locate all parts needed: Product Tank, Product Tube from ATF (correct version), Securing arm and screws. See Figure 45.



Figure 45: New product tank

- 2) Position the product tank with the 2 hose barbs facing in the direction of the ATF. Refer to Figure 46.



Figure 46: Product tank and hose barbs

- 3) Install the securing arm over the product tank, and locate the screw hole on the back case cover for the old product tank securing arm that was to the right (top side of compressor). See Figure 47.



Figure 47: Install securing arms

- 4) Locate the Product Tube - remove black ATF outlet barb cap, and attach the Product Tube Assy to the ATF output barb, secure with a cable tie. Attach the other end of the Product Tube to the Bottom port on the Product Tank.

5) Connect the Output tubing to the Top port on the Product Tank and secure with cable ties. See Figure 48.

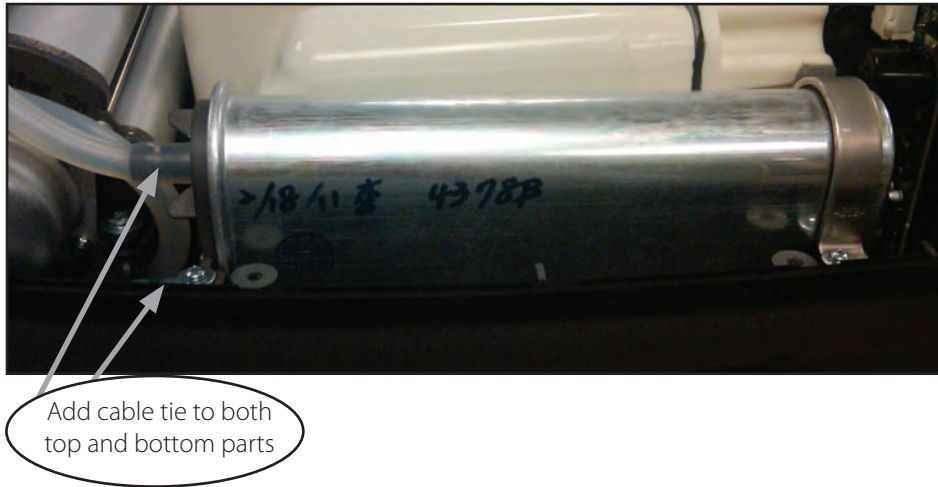

Figure 48: Connect output tubing

Situation# 2: Removing the New Style Product Tank (PN:4378-SEQ)

- 1) Follow the steps to “Remove and Replace the Front Cover Assy” on page 40.
- 2) Remove the Front Cover Assy completely; outlet tubing and front membrane ribbon cable. Set aside.
- 3) Locate the metal Product Tank and cut the cable ties from the ATF to the Product Tank(Bottom), and O2 Out from the outlet connector(Top). Remove tubing from ATF to Lower Product Tank barb and set aside for installation. See Figure 49.

Important: Cap off the ATF hose barb with a black hose barb cap.



Figure 49: Cut Cable Ties

- 7) Locate the 2 screws that hold the securing straps and the product tank in place, remove the screws. Set aside for re-installation. Figure 50.

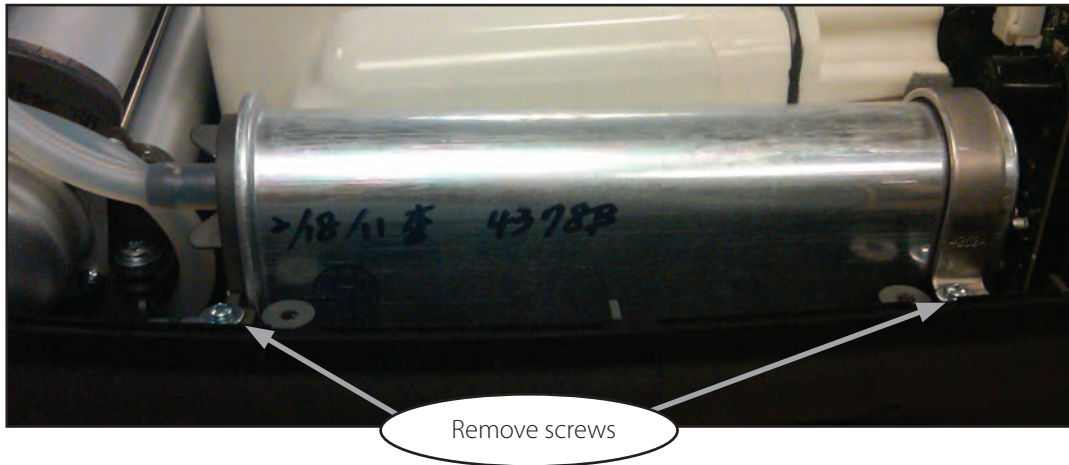



Fig 50: Remove screws

- 8) Lift out the old product tank (PN: 4378-SEQ). Set aside for RMA return or scrap.
- 9) Follow the above step to Install the New Product Tank (PN: SP4378-SEQ) above.

Electronics

REMOVE AND REPLACE THE CONTROL BOARD ASSEMBLY

CAUTION	The Eclipse contains electrostatic sensitive components. Do not open or handle except at a static free workstation.
	

NOTE:	The Control Board Assembly is factory calibrated as a single unit. Do not disassemble the Control Board Assembly.
--------------	---

1. Remove the Unit Cover as described in the section Remove and Replace the Unit Cover.

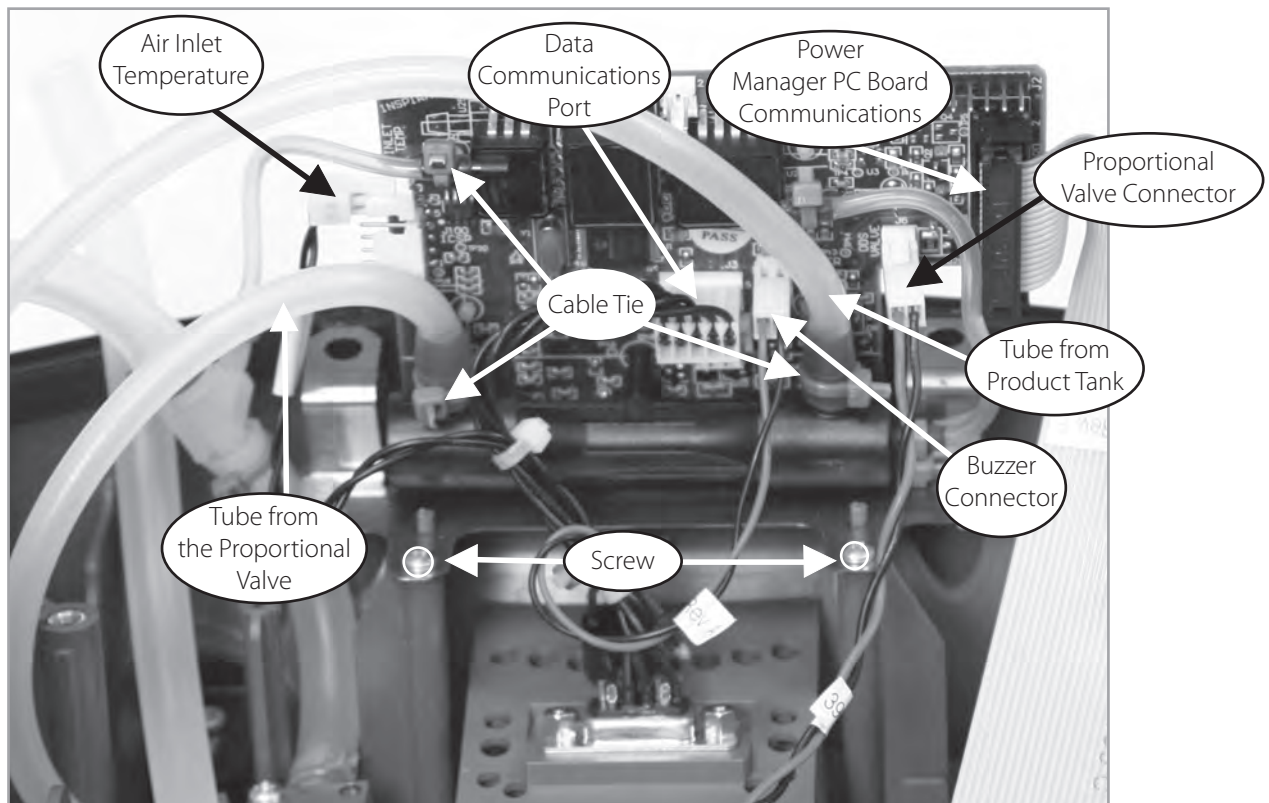

Figure 51: Control Board Removal (ATF Module not shown for clarity).

2. Remove the 2 screws (M3x10 Plastite Screw, P/N 6950-310-SEQ) holding the Control Board Assembly to the Unit Case as shown in Figure 51.

NOTE:	Use a magnetized Phillips #1 screwdriver to remove the screws. This greatly reduces the chances of dropping a screw in the Unit Case.
--------------	---

3. Lift the Control Board Assembly and disconnect the Inlet Air Temperature, Data Communications Port, Power Manager PC Board Communications, Proportional Valve wire harness, and Buzzer wire harnesses as shown in Figure 51.

4. Lift the Control Board out of the Unit. Cut the green cable tie to the silicone tube that is connected to the sensor as shown in Figure 51. Disconnect the silicone tube that is attached to the sensor. Cut the green cable ties to the silicone tubes that are connected to the flow tube as shown in Figure 52. Disconnect the silicone tubes that are attached to the flow tube.
5. Pinch or plug the silicone tube coming from the ATF product port and secure with a cable tie.
6. Remove the Control Board Assembly.
7. To install a new Control Board Assembly, cut the cable tie used to pinch the silicone tube coming from the product tank. Attach this tube and the tubes from the Proportional Valve and from the Product Tank to the flow tube as shown in Figure 51. Secure with a cable tie. Connect the silicone tube to the sensor as shown in Figure 51. Secure with a cable tie. Place the 2 screws in the sheet metal bracket as shown in Figure 52. Inspect the tubing to ensure the tubing is not kinked.
8. Lower the Control Board Assembly into the Unit Case only to where the aligning pins go through the sheet metal bracket; make sure the sheet metal bracket is 1/8" above the supporting ribs – this will ensure the 2 screws stay in the bracket and do not fall in the unit case as shown in Figure 52. Start the 2 screws by turning them 2 times into the unit case. After starting both screws, lower the Control Board Assembly onto the supporting ribs; tighten the 2 screws to the unit case.

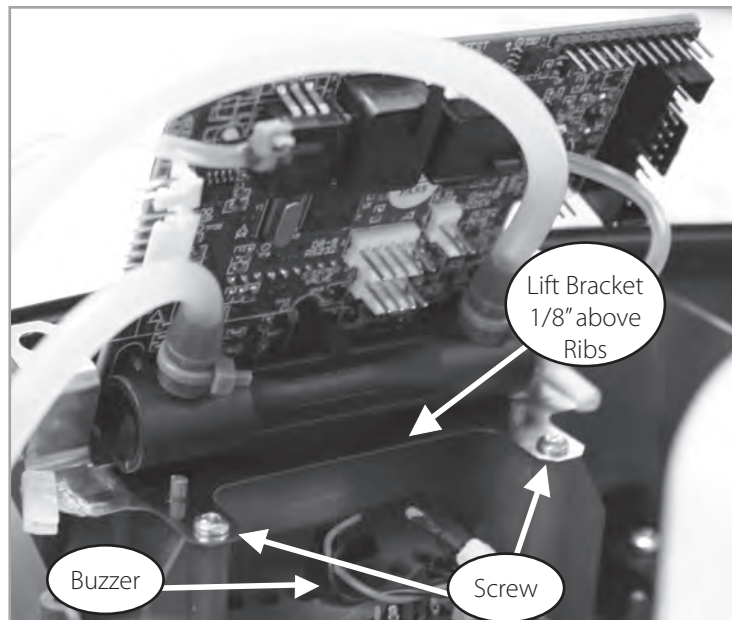

Figure 52: Control Board Installation.

9. Connect the Inlet Air Temperature, Data Communications Port, Power Manager PC Board Communications, Proportional Valve wire harness and Buzzer wire harnesses as shown on Figure 52.
10. Refer to "Flow Calibration" in EDAT User Manual (PN 5419-SEQ) to calibrate Eclipse with new Control Board.
11. Installation of the unit cover on the unit is described in the Remove and Replace of the Unit Cover.

REMOVE AND REPLACE THE BUZZER WIRE HARNESS

1. Unplug the buzzer from the Control Board PC Board.
2. Remove the Control Board.
3. To remove the buzzer from the case, cut the cable tie, grasp the buzzer body with a pair of pliers and rotate the buzzer to break the adhesive joint.
4. To install a new buzzer, apply a ring of cyanoacrylate adhesive (Super Glue) around the inlet hole as shown in Figure 53.

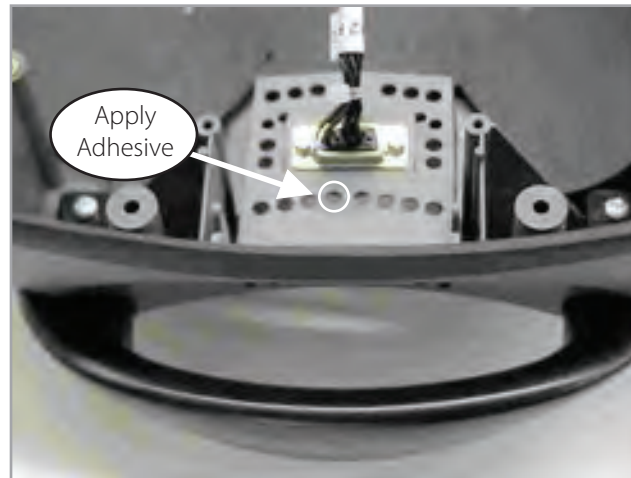

Figure 53: Bonding the Buzzer to the case.

5. Place buzzer as shown in figure 54. Ensure that the buzzer opening is centered over the grill hole. Hold in place until adhesive cures.

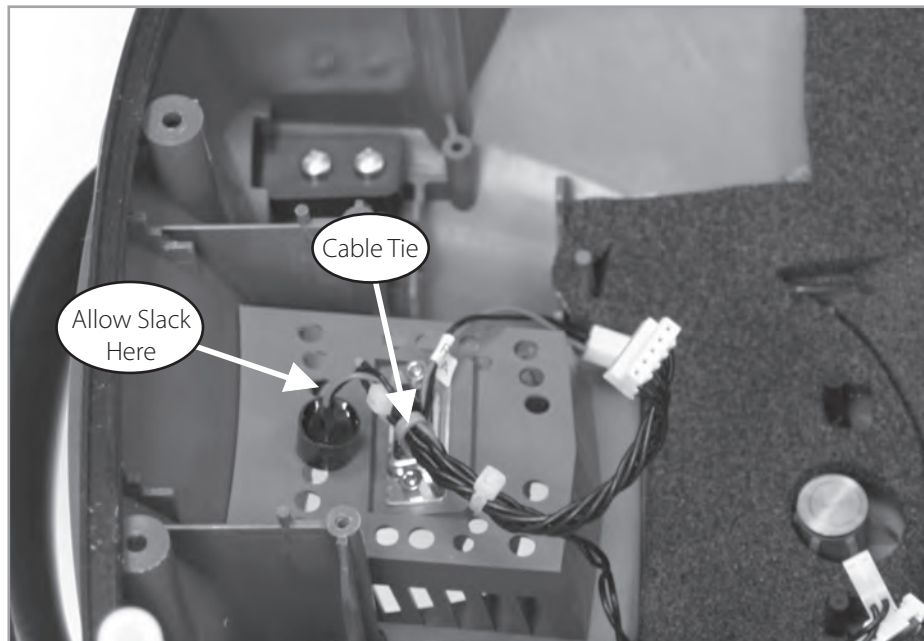

Figure 54: Buzzer Installation.

6. Install the Control Board Assembly. Secure the wire harness with Cable as shown on Figure 54. Insure that there is a slack on the wire harness before tightening the Cable Tie. Plug in the buzzer.

CONTROL BOARD CONNECTOR DIAGRAM

Use the figure below as an aid to ensure proper connection of wire harnesses to the Power Manager printed circuit board.

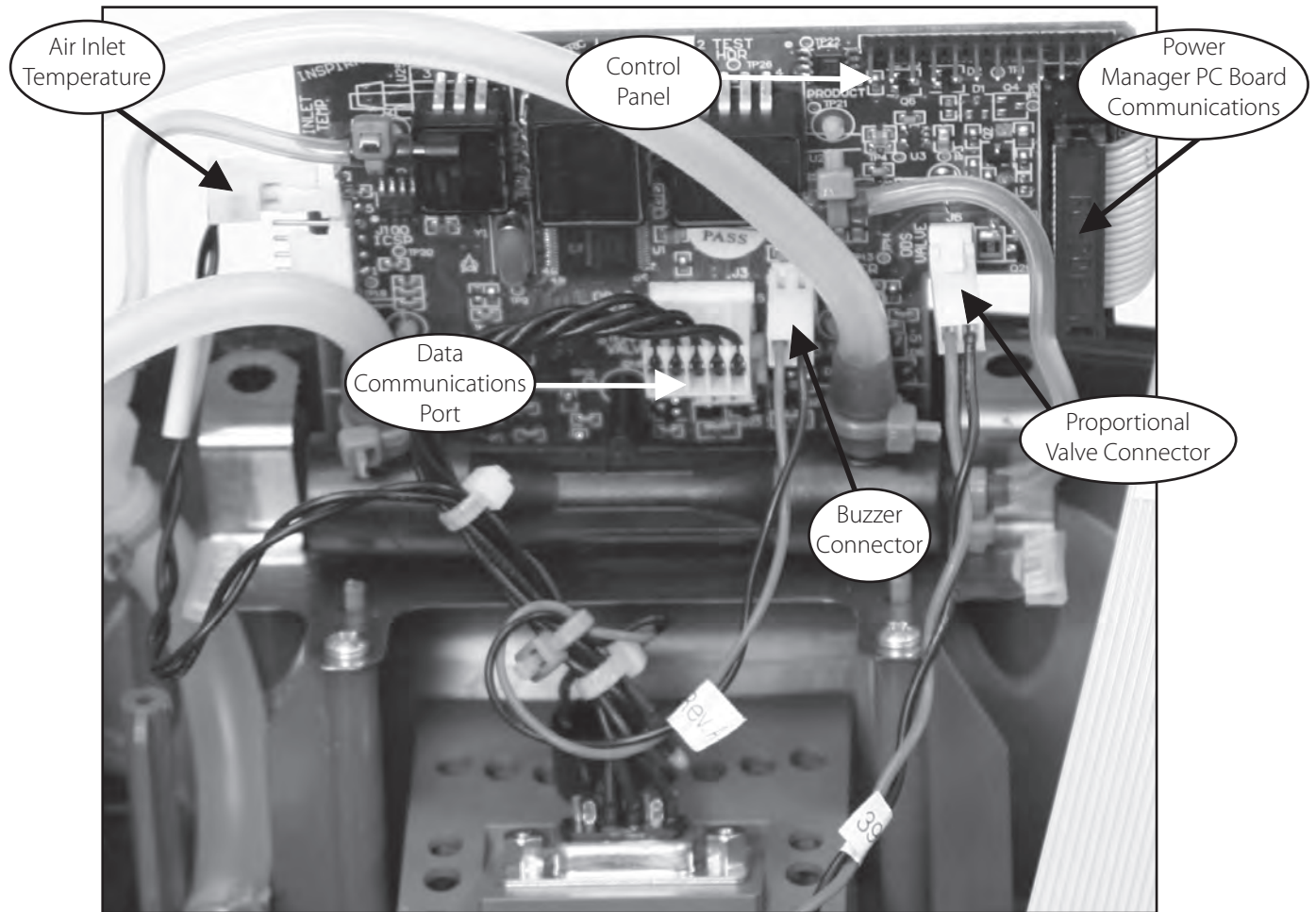



Figure 55: Control Board Connector Diagram

REMOVE AND REPLACE THE POWER MANAGER PRINTED CIRCUIT BOARD

CAUTION	
	The Eclipse contains electrostatic sensitive components. Do not open or handle except at a static free workstation.

1. Remove the Power Cartridge and unscrew the 4 screws (M3x12 Pan Head SEM Screw, P/N 6974-312-SEQ) shown in Figure 56.

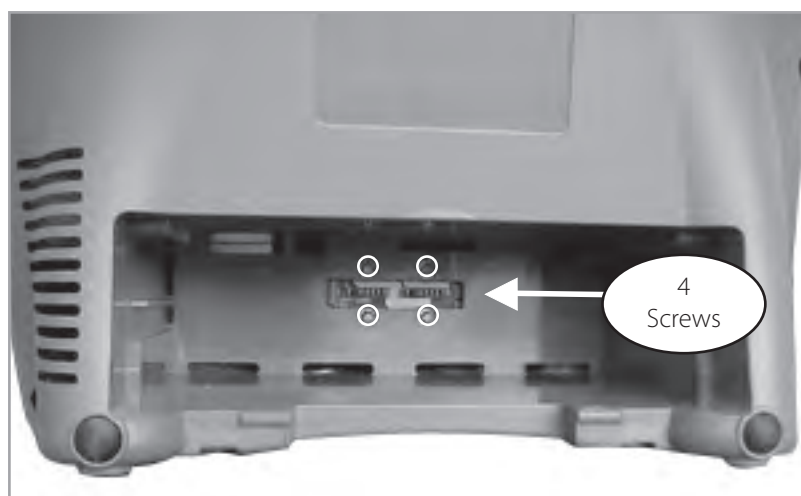

Figure 56: Battery Bridge Board Removal.

2. Remove the Unit Cover as described in the section Remove and Replace the Unit Cover.

3. Disconnect the 5 wire harnesses as shown in Figure 49. Remove the Battery Bridge PCB as shown in Figure 57.

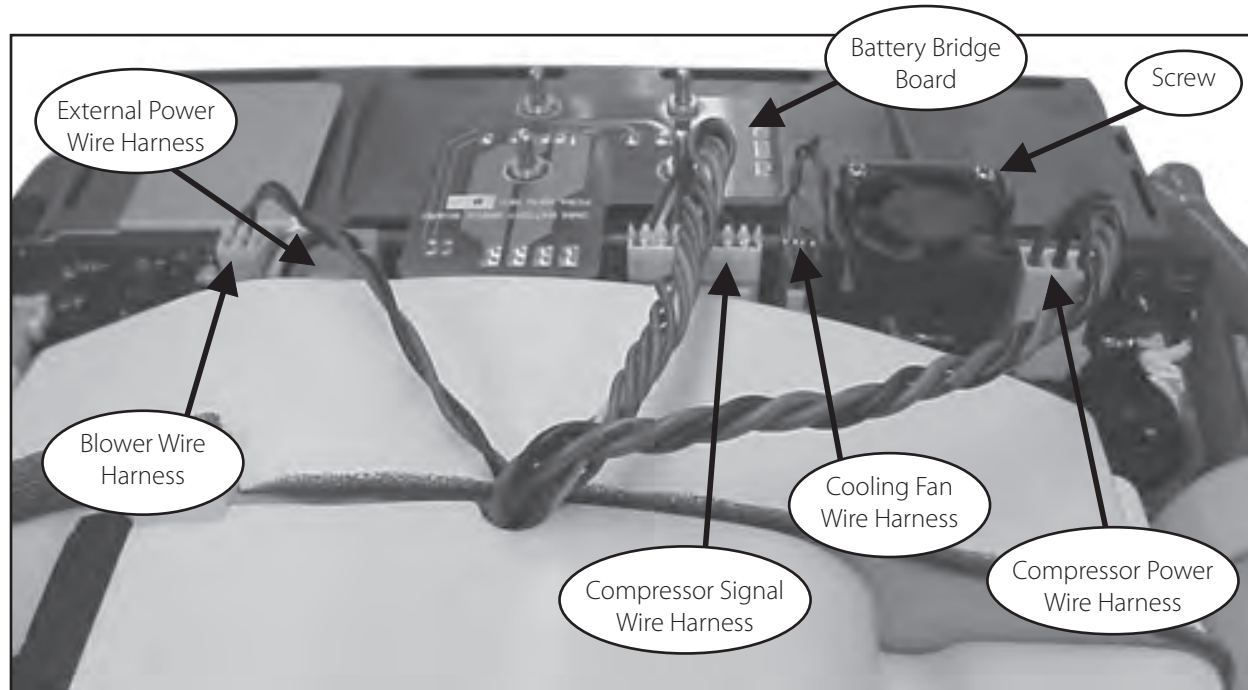

Figure 57: Power Manager PC Board Removal.

4. Unscrew the 2 screws (M2x10 Pan Head Machine Screw, P/N 6961-210-SEQ) holding the fan shown in Figure 49. Remove fan.
5. Remove the Exhaust Tube shown in Figure 58.

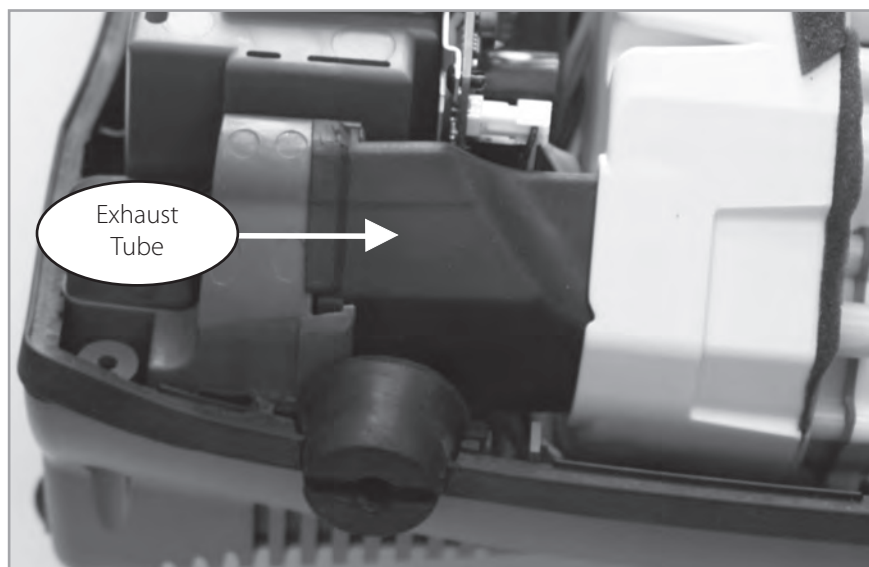

Figure 58: Exhaust Tube Removal.

6. Pull the Power Manager PCB 1" out of the unit case. Gently push the Compressor Box away from the Power Manager PCB by 1/8". Disconnect the 2 wire harnesses and the ribbon cable shown in Figure 59. Remove the Power Manager PC Board.

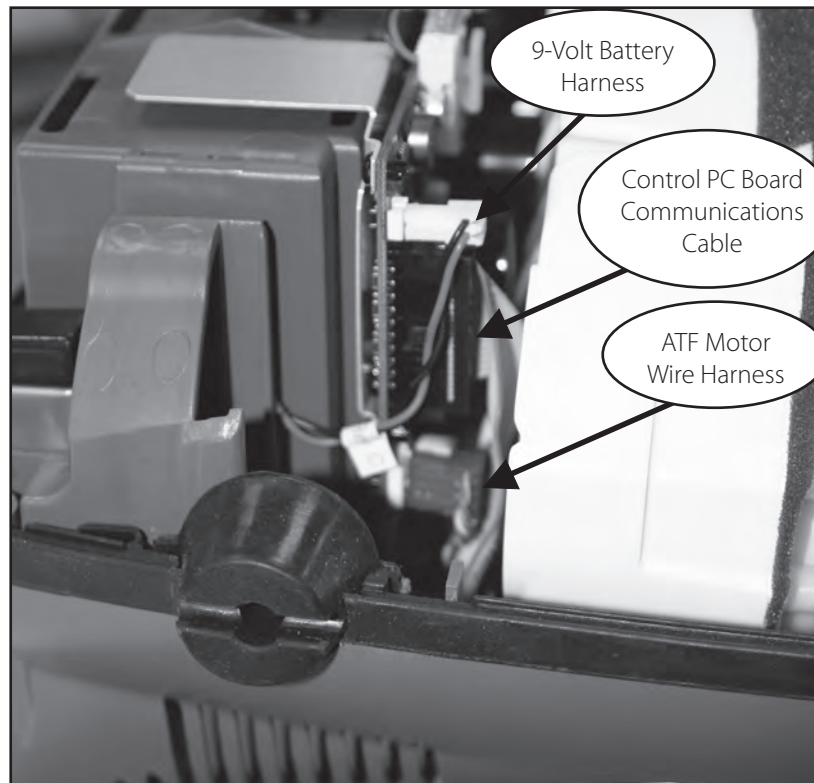

Figure 59: ATF Motor, 9-Volt Battery, and Control PC Board Communications Wire Harness Removal.

7. Position the new Power Manager PCB 1" out of the unit case as shown in Figure 60. Gently push the Compressor Box away from the Power Manager PCB by 1/8". Connect the 2 wire harnesses and the ribbon cable. Position the Power Manager PCB into the slots on the Unit Case.
8. Install the fan with the 2 screws and lightly tighten as shown in Figure 57. Apply Loctite 425 Thread Locker on the tips of the screws before installing. Ensure that it is blowing down as indicated by the arrow on the side of the Fan.
9. Install the Battery Bridge PCB and 4 wire harnesses shown in Figure 57.
10. Screw in the 4 screws shown in Figure 56.
11. Hold onto the Compressor Box and lift the Bottom Case in standing position. Insert the Exhaust Tube into the slot of the Exhaust Duct as shown on Figure 58 above. Ensure that it is secure without any gaps.
12. Install the Unit Cover as described in the section Remove and Replace the Unit Cover.

POWER MANAGER PC BOARD CONNECTOR DIAGRAM

Use the picture below as an aid to ensure proper connection of wire harnesses to the Power Manager printed circuit board.

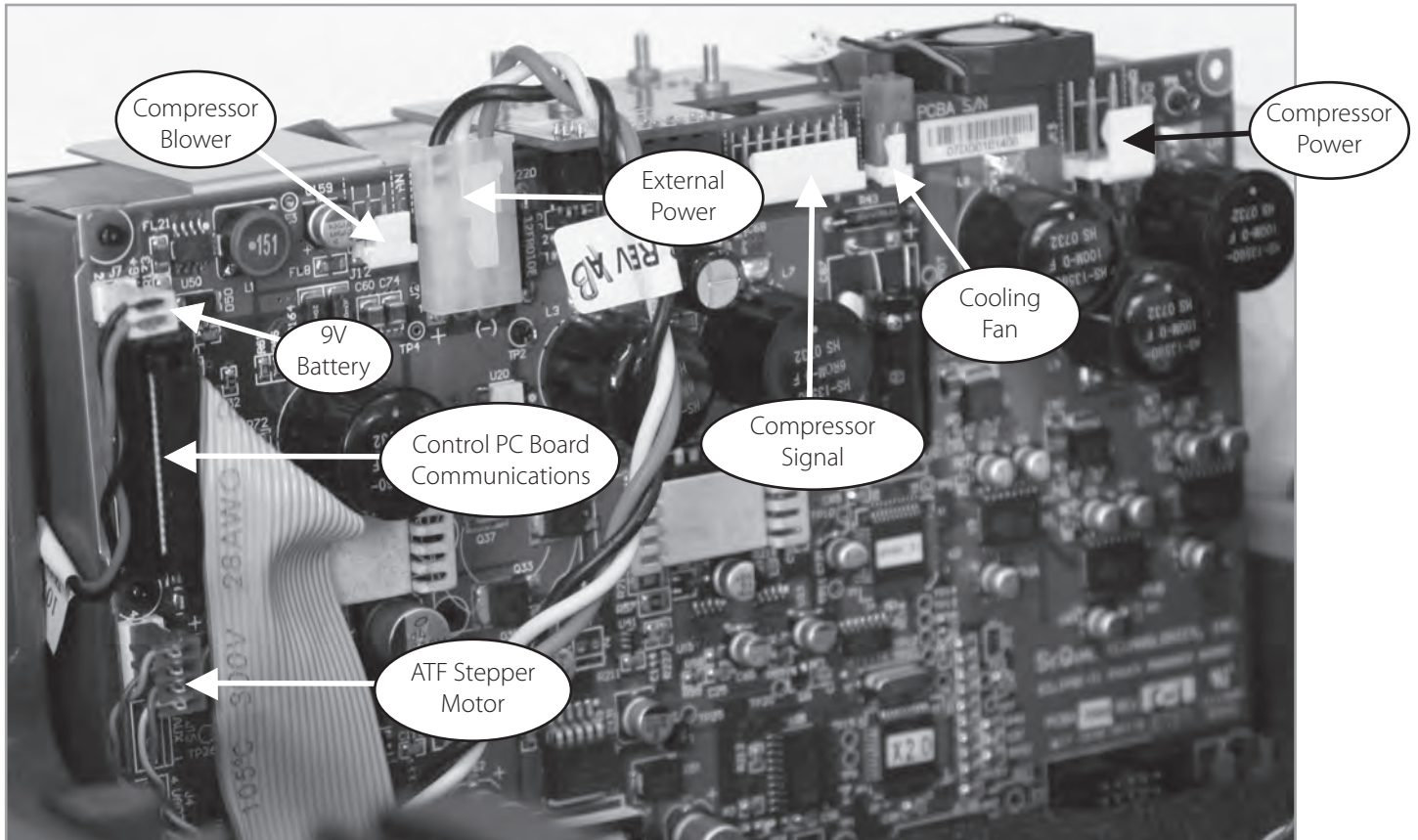

Figure 60: Power Manager PC Board Connector Diagram (Early Production E3)

POWER MANAGER PCB IDENTIFICATION

Use the picture below as an aid to ensure proper connection of wire harnesses to the Power Manager printed circuit board.

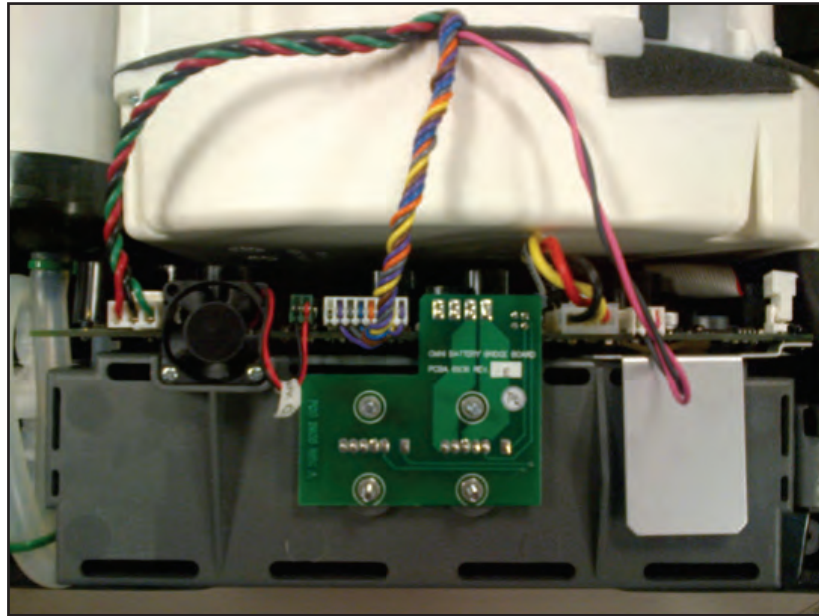

Figure 61: Previous - Separate PM pcb and BBB pcb (PN: SP3986-1-SEQ)

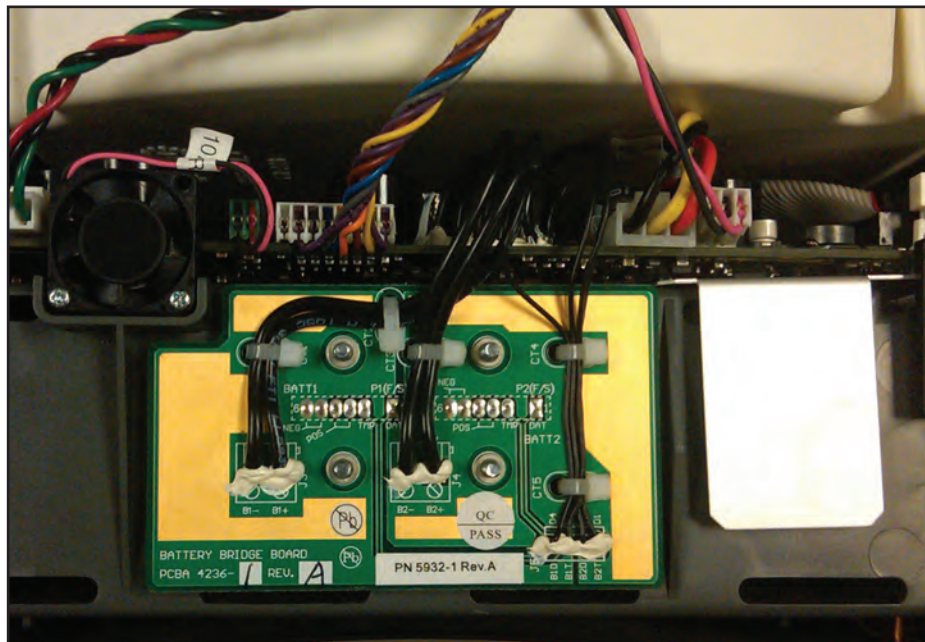



Figure 62: New Combo PM/BBB pcb (5932-1-SEQ)

A Procedure to replace the new Combo Power Manager Board and Battery Bridge Board:

1 Remove and Replace Combo Power Manager board set

WARNING:	Disconnect power supplies and remove Power Cartridge before removing the unit cover. Do not touch exposed circuits during maintenance without ESD protection.
	

1.1 Remove the Power Cartridge and unscrew the 4 screws holding the BBB pcb to the case (PN: 6974-312-SEQ) shown in Fig 63.



Fig 63: Screws

1.2 Remove the Unit cover as described in section, "Remove and Replace the Unit Cover".

1.3 Disconnect the 5 wire harnesses as shown in Figure 54. Remove the Battery Bridge pcb (BBB pcb) as shown in Fig 63 (Pull straight up and off of the Power Manager pcb.)

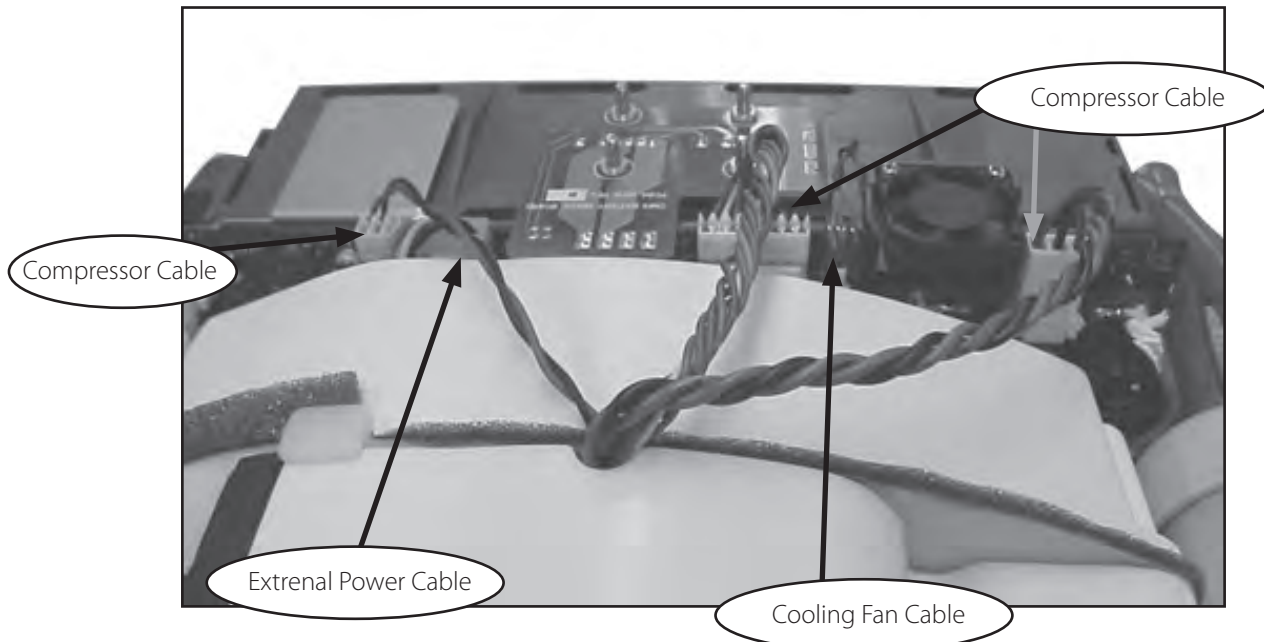

Fig 64: Cable locations

- 1.4 Unscrew the 2 Cooling Fan screws (PN: 6961-21-SEQ) holding the fan in place. Remove the Fan (PN: 1074-SEQ). Set aside for later installation.
- 1.5 Remove the Exhaust tube in Figure 65. Set aside for later installation.

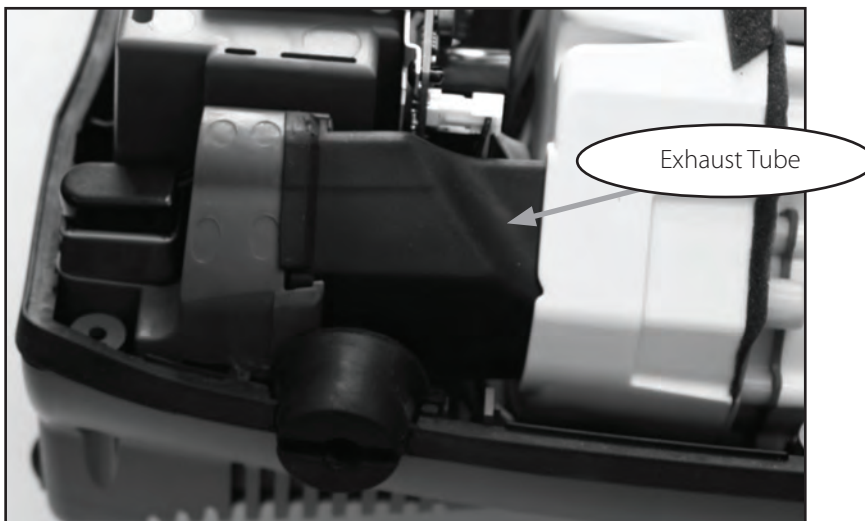

Fig 65: Exhaust Tube

- 1.6 Pull the Power Manager pcb 1" out of the case. Gently push the compressor box away from the Power Manager pcb about 1/8". Slide the board and the cabling out from under the edge of the compressor for better access. Disconnect the two wire harnesses (9V batt & ATF harness) and the Control board ribbon cable shown in Figure 66. Remove the Power Manager pcb.

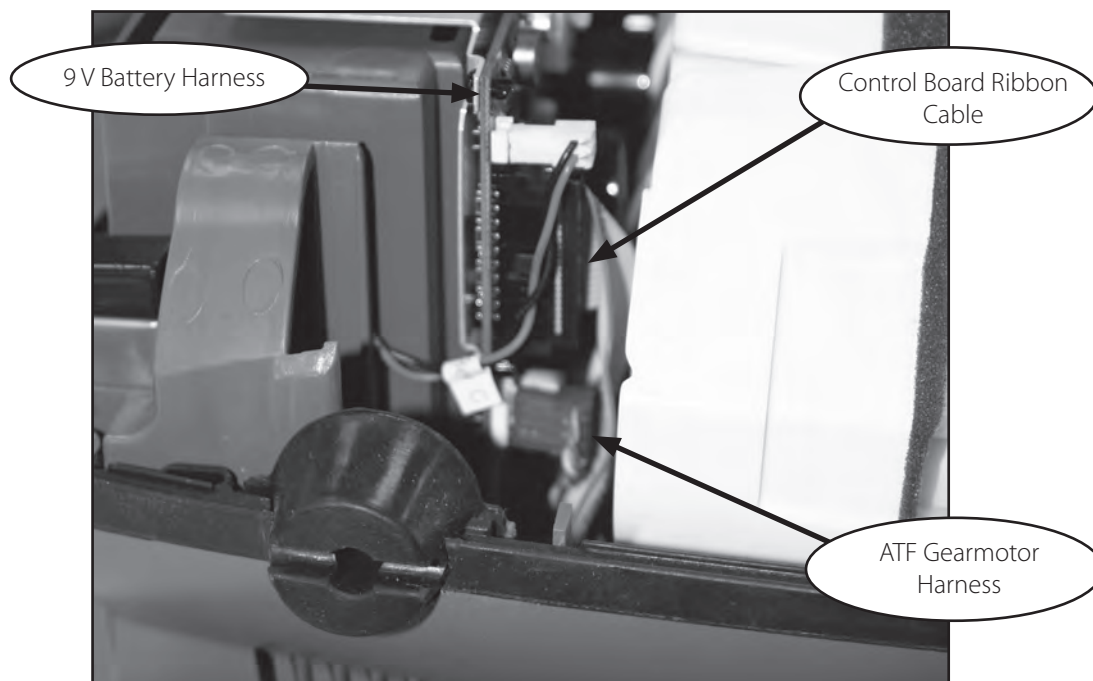

Fig 66: Wire harnesses and control board ribbon

1.7 Unbox the SP5932-1-SEQ and account for all parts (Fig 67).

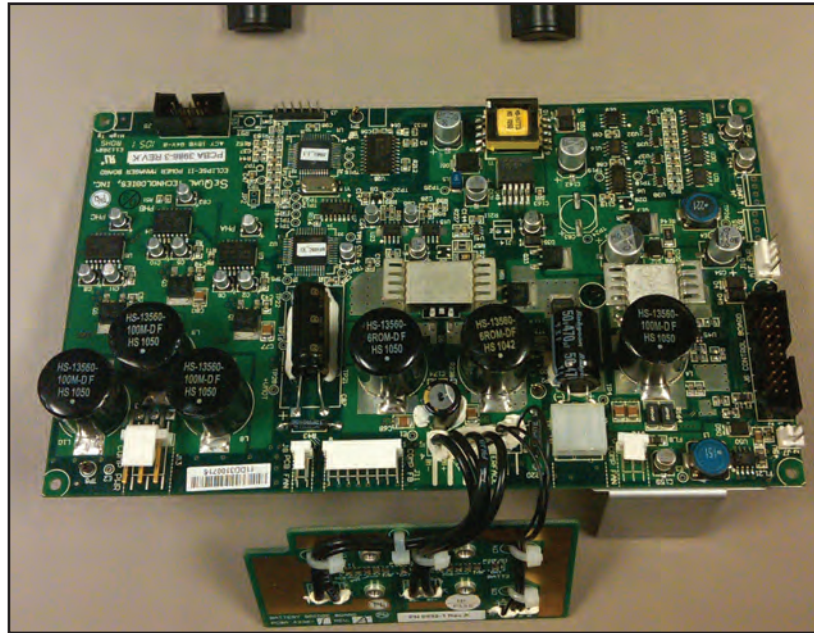

Fig 67: New Power Manager

1.8 Position the New Power Manager PCB(PN: 5932-1-SEQ) 1" out of the case as shown in Fig 58. Gently push the Compressor Box away from the Power Manager pcb by 1/8". Connect the 2 wire harnesses (Ext Power & ATF harness) and the Control Board Ribbon Cable.

Note: Route the wiring under the edge of the compressor. Position the Power Manager PCB into the alignment slots on the back case. Finally connect the 9V batt wiring harness (between the exhaust & battery compartment) and 3 Compressor wiring harnesses to their connectors.

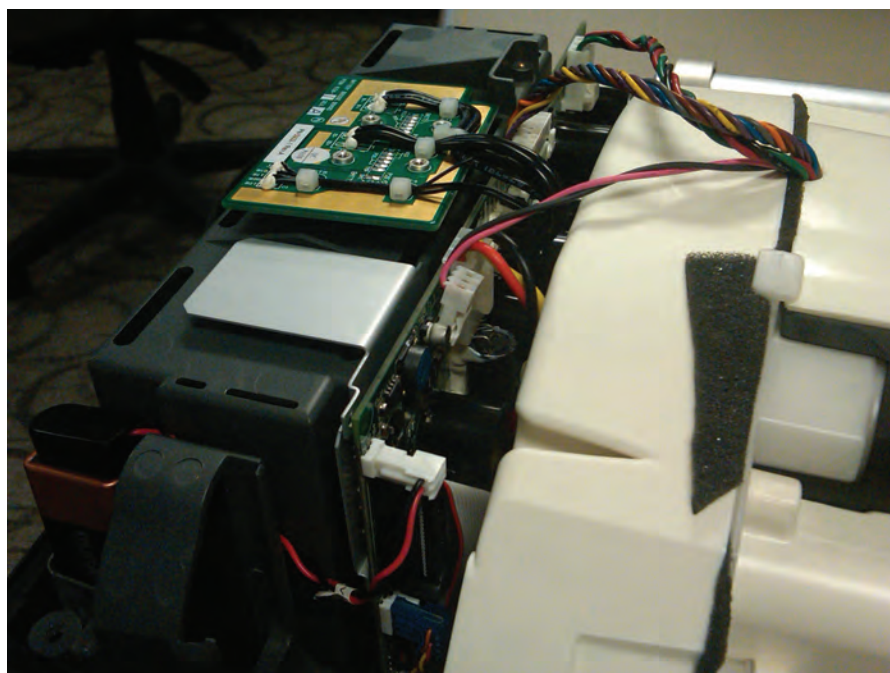

Fig 68: Routing Wires

1.8 Install the Cooling Fan (PN: 1074-SEQ) with the 2 screws (PN: 6961-210-SEQ) and lightly tighten as shown in Fig 69. Apply Loctite 425 thread locker on the tips of the threads before installing.

Note: Ensure the cooling fan is blowing down as indicated by the arrow on the side of the fan.

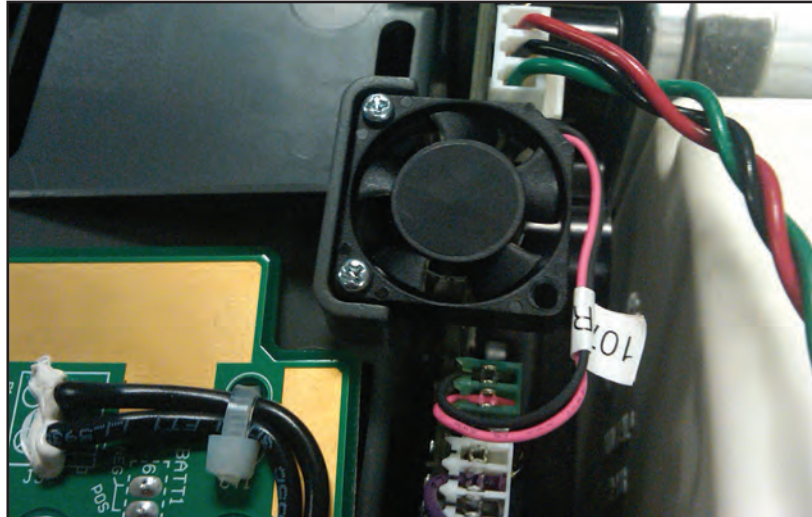

Fig 69: Cooling Fan placement

1.9 Turn the device over and align the BBB with the holes in the case. Screw the 4 screws into the Battery Bridge Board from the Battery compartment side, securing it to the case (snug screws).

1.10 Turn the device back over. Install the 2 clips that come with the power manager board (SP5932-1-SEQ) set. **Note:** There is a right and left clip - Large gap is on the right - ensure you get both the metal heat sink and pcb corner in the black clip.

1.11 Install the Unit's front cover according to the "Remove and Replace front cover" section. This holds the Power Manager pcb corner clips in place (no screw required).

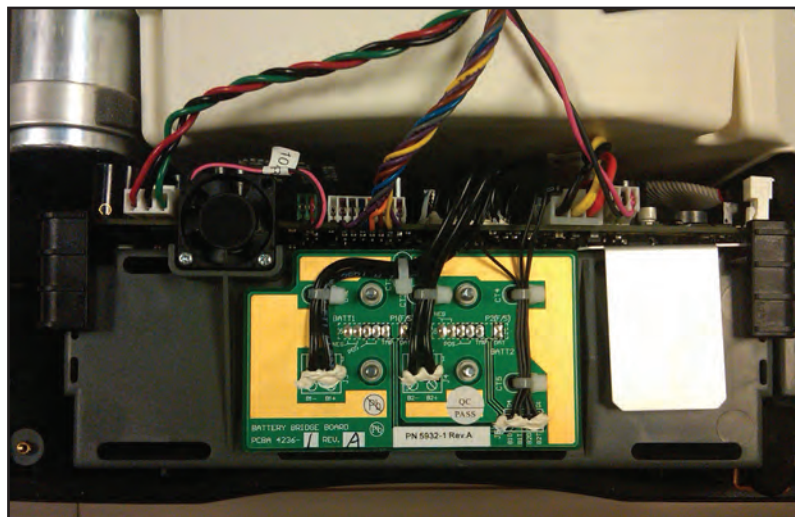

Fig 70: Power Manager installed

1.12 NOTE: Once installed, the software of the device will need to be updated. Currently the only approved method to update the software with this Power Manager board is the "eLoader" program . This program is copyrighted and is proprietary to Chart-SeQual Technologies - Call Tech Support and schedule return the device to an AUTHORIZED SERVICE CENTER for software update.

Compressor

As with any concentrator, the compressor is a limited-wear component and may require servicing during the lifetime of the device. The point of service will be dependent on factors such as operation time, flow settings and environmental conditions. Service is required when O₂ purity and/or flow rates cannot be maintained.

REMOVE AND REPLACE THE COMPRESSOR BOX

NOTE:	There are no field serviceable parts inside the Compressor Box. Do not attempt to disassemble or modify the Compressor Box in the field.
--------------	--

1. Remove the Unit Cover as described in the section Remove and Replace the Unit Cover.

CAUTION	The Eclipse contains electrostatic sensitive components. Do not open or handle except at a static free workstation.
	

2. Flip unit over onto a padded ESD safe surface. Using a small flat tip screwdriver to pry open the cover at each pry point, remove the Case Bottom Cover as shown in Figure 66.

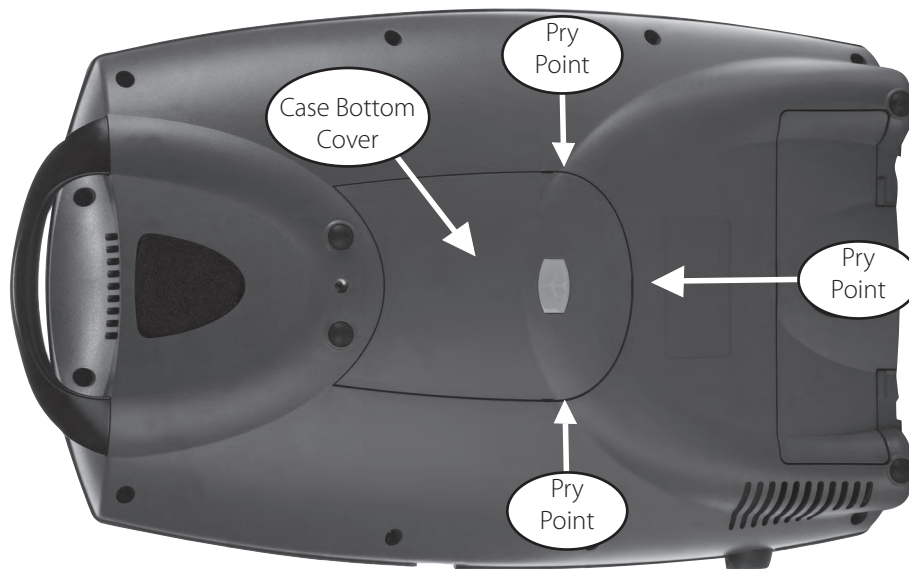

Figure 71: Case Bottom Cover Removal

3. Disconnect the 3 wire harnesses shown in Figure 72.

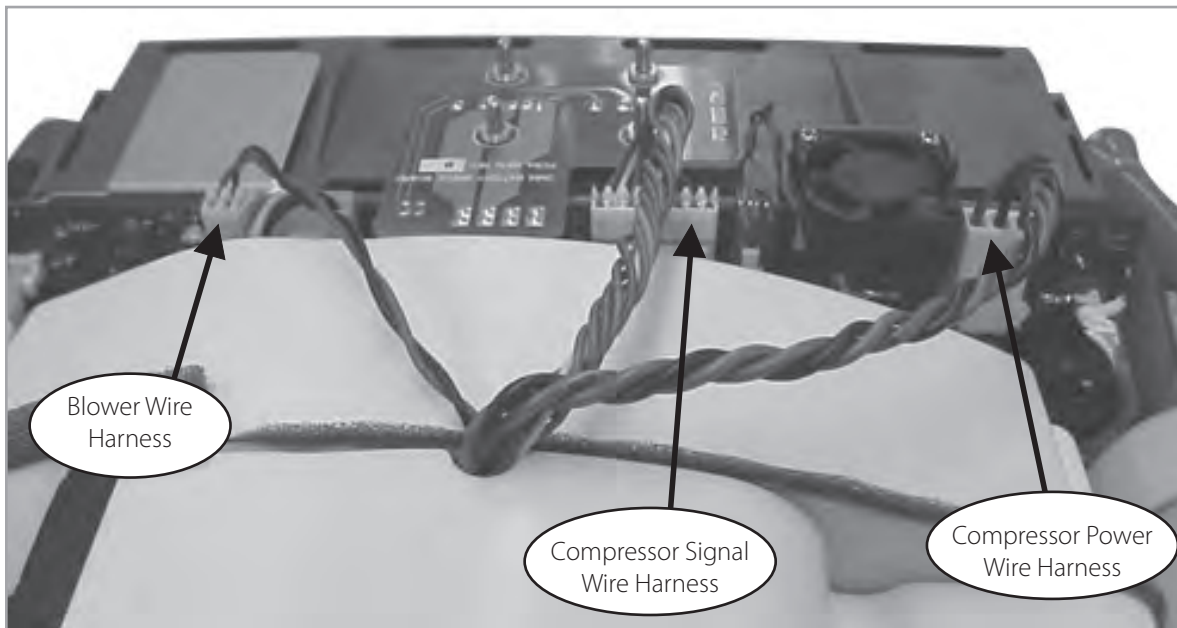

Figure 72: Compressor Box electrical connections.

4. Remove the Exhaust Tube as shown in Figure 73.

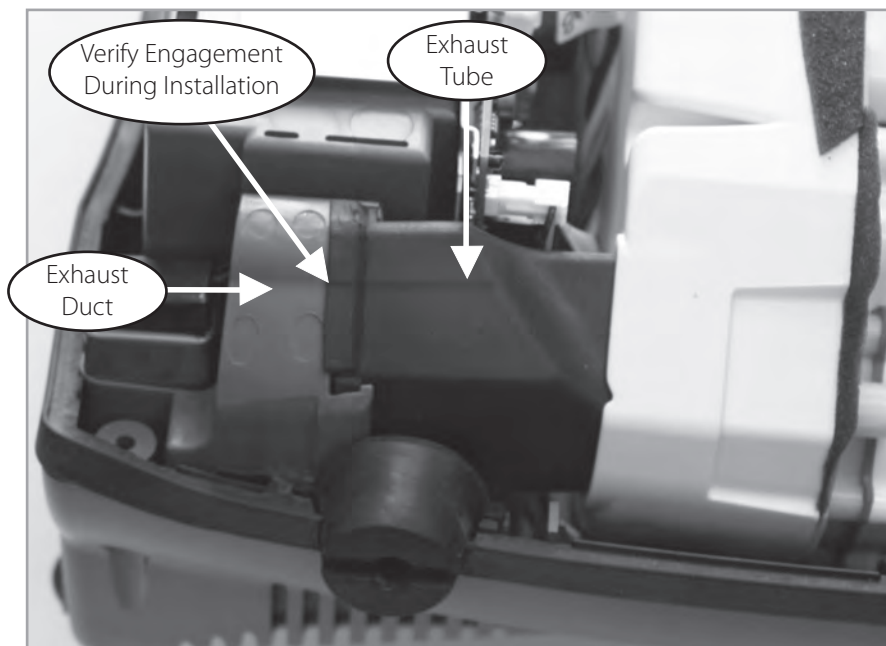



Figure 73: Exhaust Tube Removal.

5. Cut the three green cable ties shown in Figure 74. Disconnect the two braided hoses from the pressure and vacuum ports of the ATF. Cap the three ATF module ports using tight fitting vinyl caps or vinyl electrical tape.

CAUTION	Once the braided hoses are disconnected from the ATF Module the ATF Module is exposed to the atmosphere. Cap the ATF Module ports immediately in order to minimize exposure to debris and humidity which may result in ATF Module damage.
	

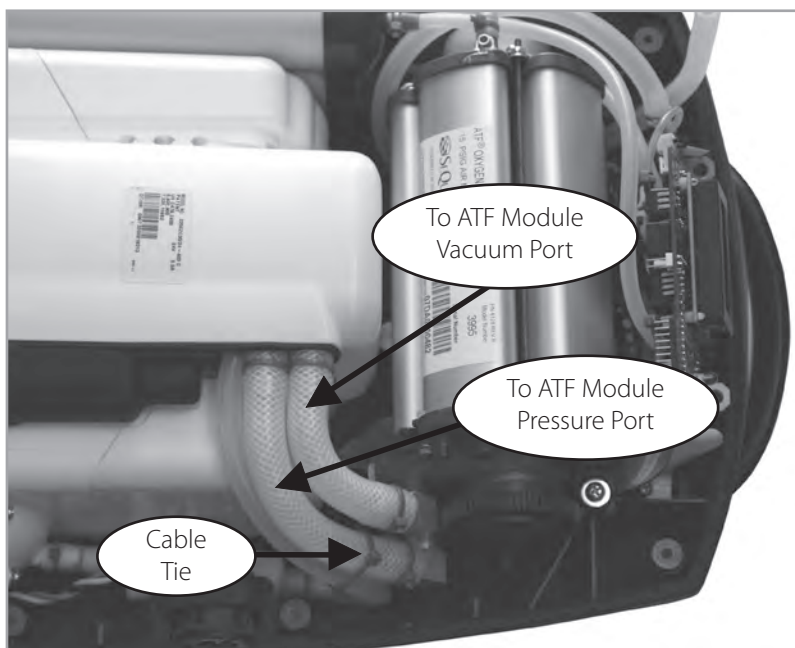

Figure 74: Removal of Compressor Pressure and Vacuum Hoses from ATF Module.

6. Turn the unit over onto a padded ESD safe surface and remove the 4 screws (M4x16 Pan Head Machine Screw , PN 6961-420-SEQ) and washers (M4 Flat Fender Washer, PN 3568-SEQ) shown in Figure 75.

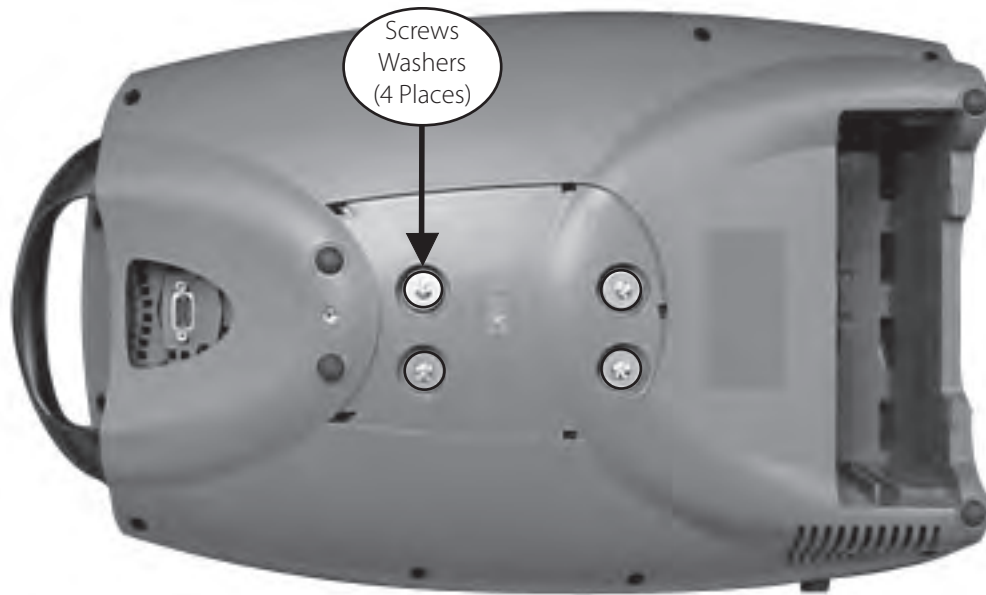

Figure 75: Remove Compressor Box screws.

7. Remove the Compressor Box.

NOTE:

There are no field serviceable parts inside the Compressor Box. Do not attempt to disassemble or modify the Compressor Box in the field.

8. To install the Compressor Box, Lay the new Compressor Box in the Unit. Turn over the Unit.
9. Position the Compressor Box into the Bottom Case with the compressor box screw holes aligned with the 4 brass eyelets. Screw in the 4 screws and 4 washers as shown in Figure 75. Apply small amount of Loctite 425 on the threaded tips of the screw before installing.
10. Install the braided tubes into the ATF pressure and vacuum ports as shown on Figure 74 on previous page. Secure joints with cable ties.
11. Use a cable tie to secure the silicone tube to the braid tube to ensure that there is NO kinking on the bend as shown on Figure 74 on previous page. Hand tightens the cable tie. Inspect the tubing to ensure the tubing is not kinked.
12. Hold onto the Compressor Box and lift the Bottom Case into a standing position. Insert the Exhaust Tube into the slot of the Exhaust Duct as shown on Figure 73 on page 90. Ensure that it is secure without any gaps.
13. Plug the 3 harnesses into the Power Manager PCB as shown on Figure 72.
14. Install the Case Bottom Cover as shown in Figure 71.
15. Install the Unit Cover as described in the section Remove and Replace the Unit Cover as outlined on page 49.
16. EDAT may be utilized to record Eclipse device status and dates of service.

MAINTENANCE AND REPLACEMENT PARTS

Preventative Maintenance Parts

Description	SeQual Part Number
Preventive Maintenance Kit (includes * items)	5022-SEQ
* Air Inlet Filter	7028-SEQ
* Compressor Intake Filter	8069-SEQ
* HEPA Filter (Old /New)	6986-SEQ / 9765-SEQ
* 9V Battery	8098-SEQ
* Wire Ties (Qty 10)	5268-SEQ
EDAT (Service Tool)	5535-SEQ

Replacement Parts List

Description	SeQual Part Number
AC Power Supply	5941-SEQ
ATF Module Assembly, Eclipse 3	SP5494-SEQ
Cable harness, SPI/ I2C	8076-SEQ
Carton Assembly, Eclipse Oxygen System	SP3581-SEQ
Case Bottom Cover	1029-SEQ
Case Bottom Subassembly, Eclipse 3	SP4242-SEQ
Case Top Subassembly, Eclipse 3	SP4241-SEQ
Compressor Box Assembly, Universal	SP5999-SEQ
Control System PCBA, Eclipse 3	SP3941-6-SEQ
DC Power Supply	5942-SEQ
Foot, bottom	6956-SEQ
Handle	6963-SEQ
Inlet Filter	7028-SEQ
Membrane Panel Overlay, Eclipse 3	SP4225-SEQ
Nut, Outlet	2777-SEQ
Outlet Assembly, Oxygen	3922-SEQ
Power Manager PCBA, Eclipse 3 (Not Field Replaceable)	SP5932-1-SEQ
Power Cartridge	7082-SEQ
Product Tank Assembly (Old / New)	6138-SEQ / SP4378-SEQ
Rubber Gasket (Channel Seal)	4106-2-SEQ
Screw, M2x10 Pan Head Machine (Cooling fan)	6961-210-SEQ
Screw, M3x10 Plastite (CS pcb, Product Tank, 9V Batt harness)	6950-310-SEQ
Screw, M3x12 Pan Head SEM (Top to Bottom case, BBB PCB)	6974-312-SEQ
Screw, M4x16 Pan Head Machine (ATF to Bottom case)	6961-416-SEQ
Screw, M4x16 Pan Head Machine (Compressor to Bottom Case)	6961-420-SEQ
Tubing, Silicone, 3/16" ID	SP6981-SEQ
Tubing, Silicone, 2mm ID	SP4101-SEQ
Tubing, Braided, 5/16" ID	SP3534-SEQ
Washer, M3 Flat	6950-03-SEQ
Washer, M4 Flat	6985-04-SEQ
Washer, M4 Flat Fender	3568-SEQ
Wire harness, 9V	1076-SEQ
Wire Harness, Service Port	7012-SEQ
Wire Harness, External Power, Eclipse 3	4063-SEQ
Kit, Preventative Maintenance	5022-SEQ

ECLIPSE OPTIONAL ACCESSORIES

Visit us at www.sequal.com for more information about optional accessories. There are many different types of oxygen tubing, cannula, and humidifiers. The following items are recommended by SeQual Technologies for use with the Eclipse.

Salter Labs® Humidifier, Part Number 7600, or equivalent: If your physician has prescribed an optional humidifier, follow the manufacturer's instructions for use. Attach the humidifier to the oxygen outlet port of the Eclipse. Use of optional humidifiers not recommended for the Eclipse may impair performance of the device and may void the warranty.

DO NOT use a humidifier in the Pulse Flow Mode. The Eclipse will not detect inspiratory effort. The device will alarm and default to the Continuous Flow Mode for continuing operation after 15 seconds.

SeQual Technologies Humidifier Adapter – Part Number 7116-SEQ: If your physician has prescribed an optional humidifier, you may need to use the SeQual Humidifier Adapter. Follow the instructions for use. Attach the Humidifier Adapter to the oxygen outlet port of the Eclipse and then to the humidifier. Attach the cannula, or oxygen tubing to the humidifier outlet.

Salter Labs Oxygen Supply Tubing, Part Number Series 2000, or equivalent: The internal diameter should be no less than 3/16" (0.48 cm). Connect the oxygen tubing to the outlet port of the humidifier, or directly to the oxygen outlet port of the Eclipse if you do not use a humidifier. Connect the other end of the tube to the nasal cannula, if oxygen supply tubing is not already attached to the cannula. Tubing not specified for use with this Eclipse may impair the performance of the device.

Salter Labs Oxygen Cannula, Part Number 1600 Series, or equivalent: Your physician will have prescribed a cannula to deliver oxygen. In most cases they are already attached to the oxygen tubing. If not, follow the instructions included with the cannula to attach it to the oxygen tubing. Use of an oxygen cannula not specified for use with this Eclipse may impair the performance of the device.

CHART SEQUAL CUSTOMER SERVICE CONTACT INFORMATION

If you need any additional assistance, contact SeQual:



By mail:

Chart SeQual Technologies, Inc.
2200 Airport Industrial Drive, Suite 500
Ball Ground, GA 30107 USA

By telephone: 800.482.2473

By E-mail: techservice.usa@chart-ind.com

www.sequal.com

AUTHORIZED EUROPEAN UNION REPRESENTATIVE:



Medical Product Services GmbH
Borngasse 20
35619 Braunfels, Germany

E-mail: techservice.europe@chart-ind.com

www.sequal.com

SeQual[®] and ATF[®] are registered trademarks of Chart SeQual Technologies Inc.

Eclipse[®] is a trademark of Chart Sequal Technologies Inc.

PRO₂ Check Elite[™] is a trademark of Salter Labs Inc.

Lysol[®] is a registered trademark of Reckitt Benckiser, UK.

Loctite[®] is a registered trademark of Loctite Corporation, USA.

