



2000 Liter VHP



Operating Manual

Manual Addendum #11869772



TABLE OF CONTENTS

1	Overview	3
2	Illustrations & Parts Listings	5
3	Specifications	9

Revision Log	Description
Rev A (12/03)	Initial product release

The Perma-Cyl 2000 is an innovative design evolving from proven technology we have been using for years on our liquid cylinders. What makes the Perma-Cyl design revolutionary is the fast fill capability, no loss/low loss fill with automatic fill termination, extended hold time and telemetry compatibility. When filled by an Orca, the Perma-Cyl vessel is designed to have an actual fill-time of three minutes or less (smaller models) with zero losses under normal conditions. The vessel will allow liquid to be held for long periods without venting, limiting product losses during periods of nonuse. The new Cyl-Tel gauge features an accurate user-friendly display and is "telemetry ready" to connect to Chart's multiple telemetry platforms.

This manual is an addendum to include the new Perma-Cyl 2000VHP model. For all filling, operating and safety instruction, please refer to the standard Perma-Cyl Operating Manual (PN 10961999).

This cylinder was designed for the volume MicroBulk user in mind. The cylinder uses the most advanced pressure building and vaporization technology today. Below are the overall dimensions of the cylinder. Replacement parts and cylinder specifications are in the sections that follow.

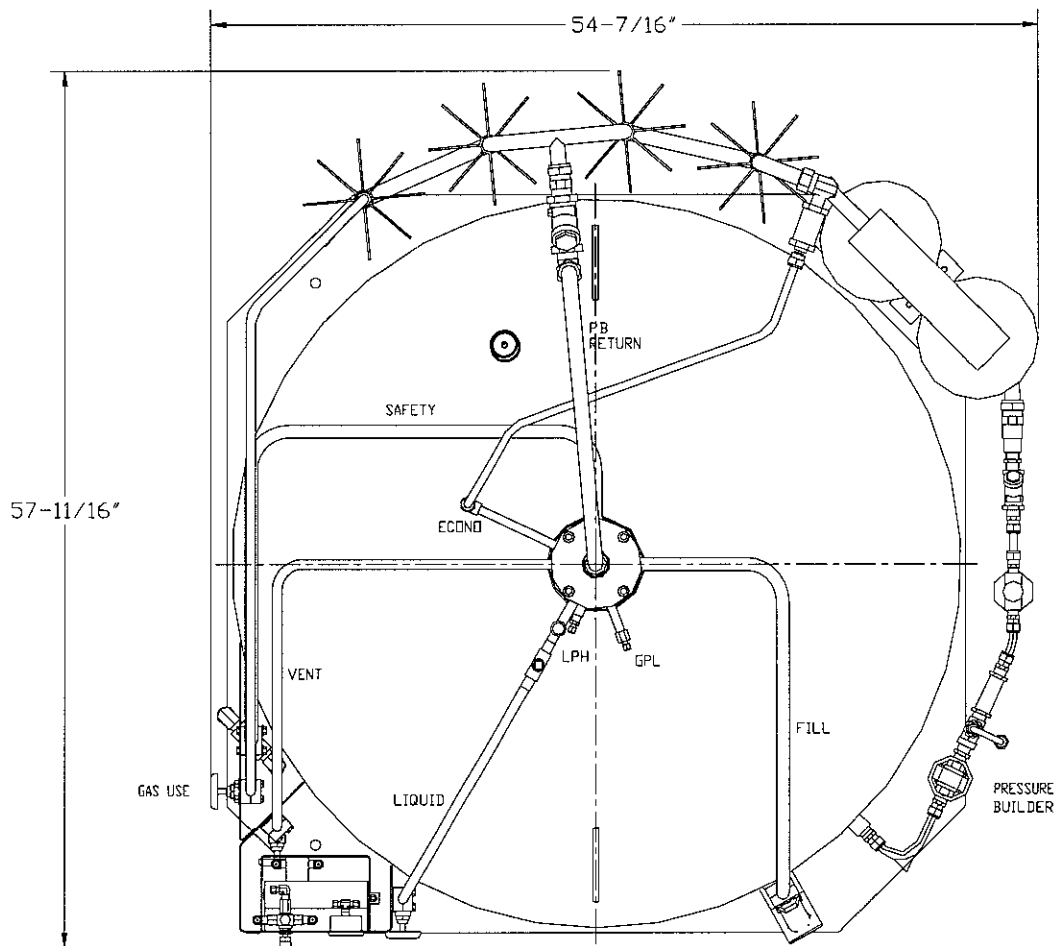

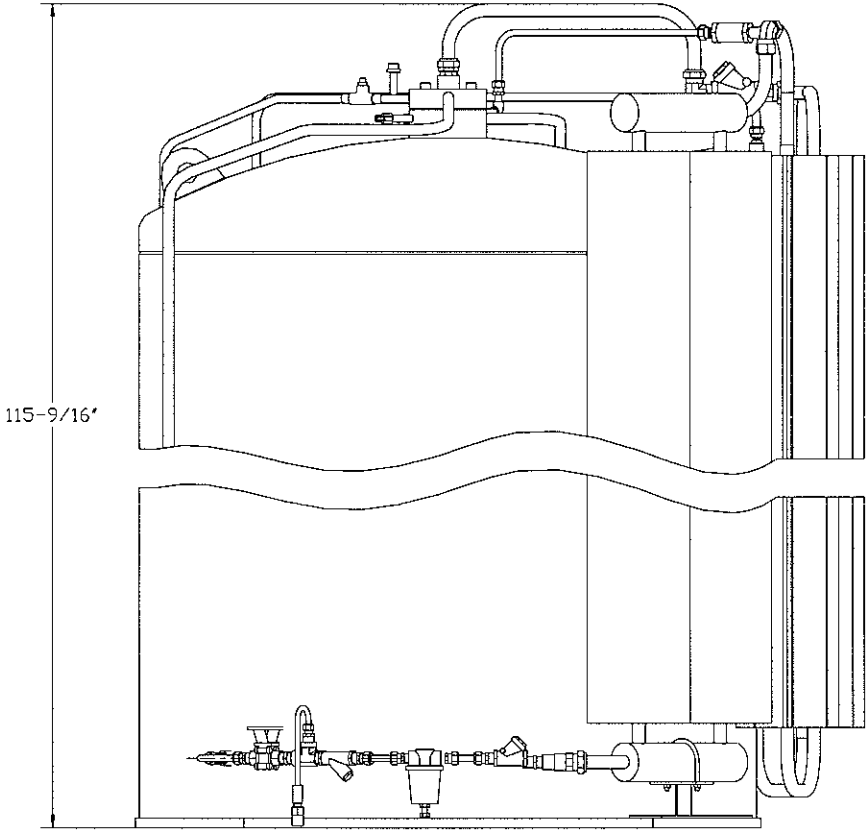

PERMA-CYL 2000VHP PLUMBING COMPONENTS

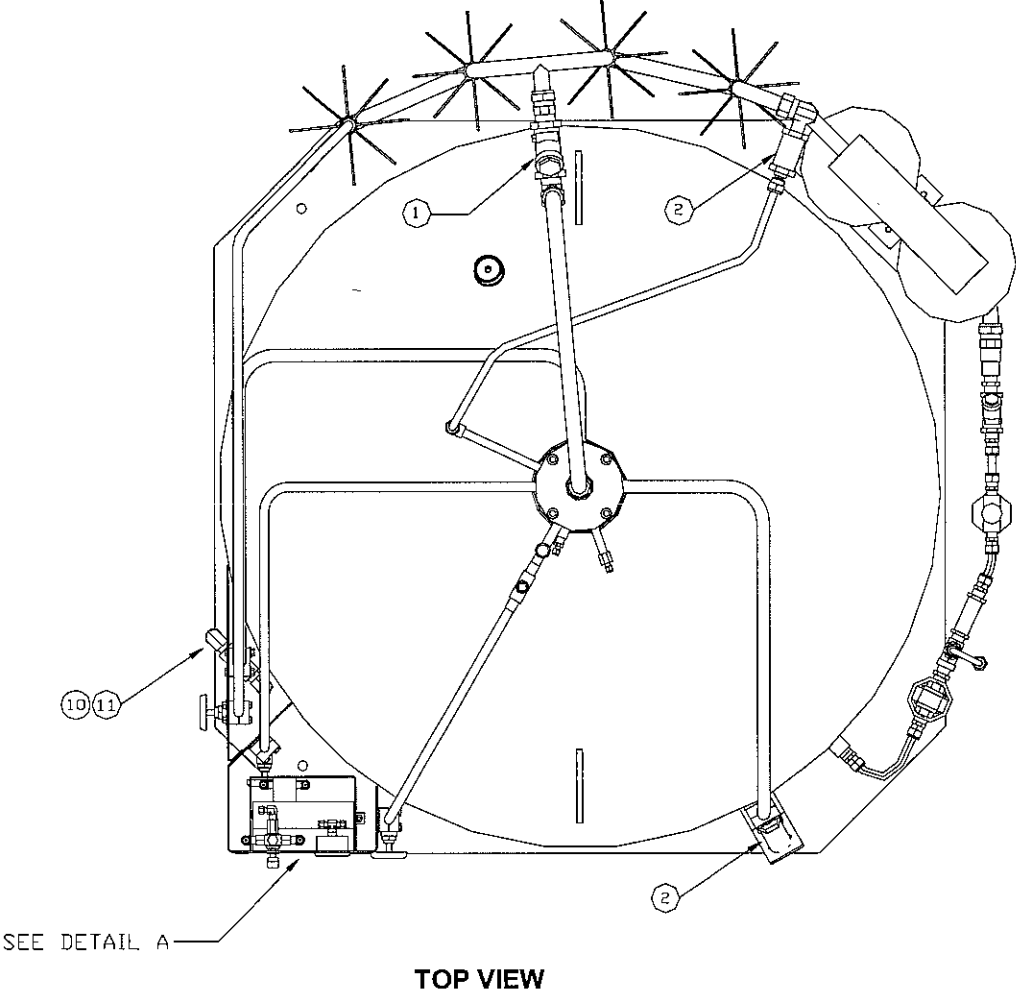

TOP VIEW

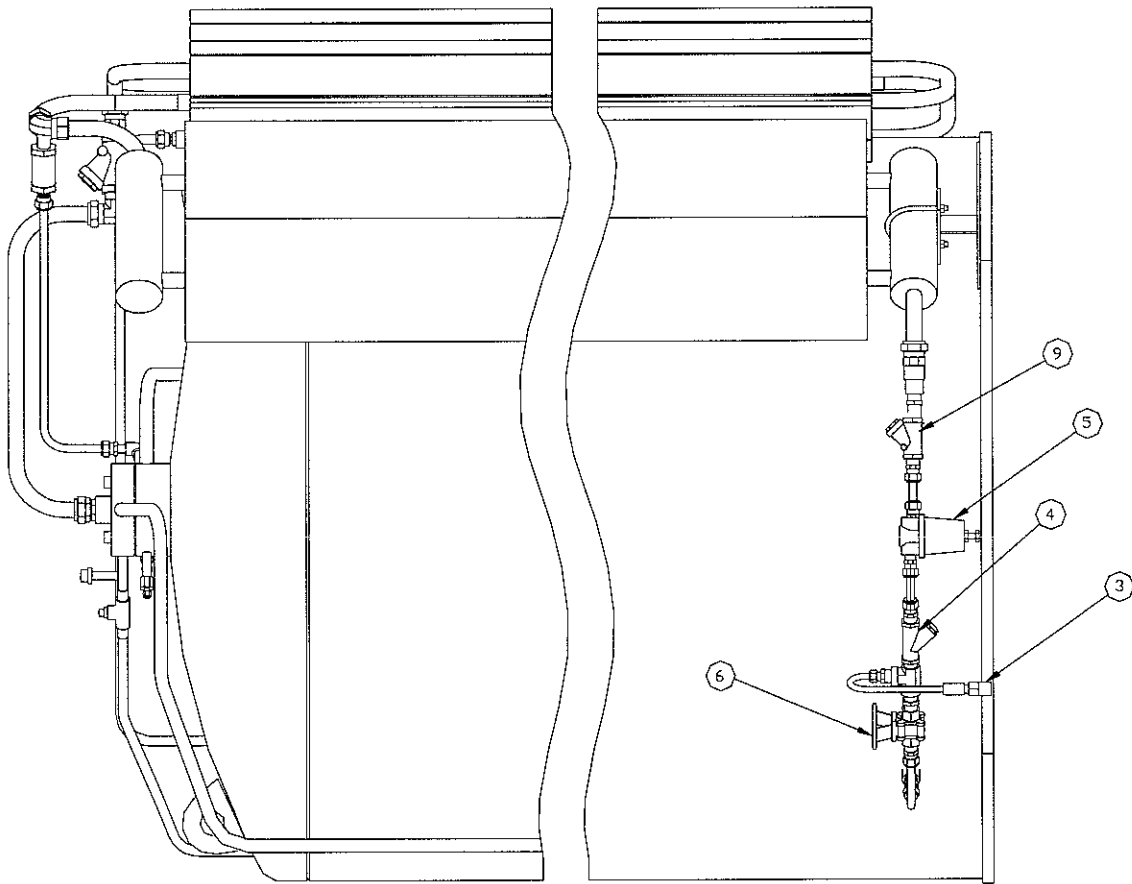



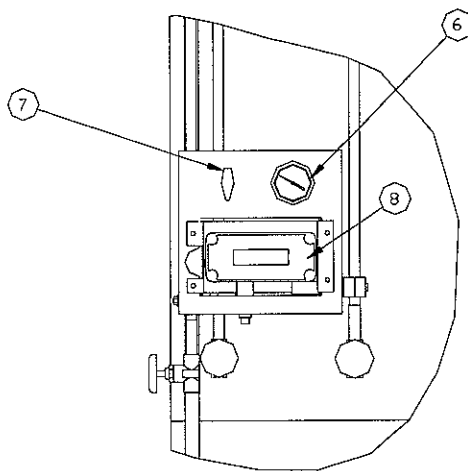



SIDE VIEW



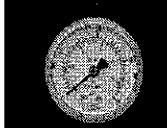

DETAIL A

PERMA-CYL 2000 VHP STANDARD:

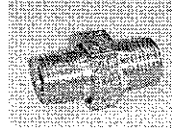
ITEM	PART NO.	DESCRIPTION
1	11656072	Check Valve 1" 600WOG
2	11051090	Check Valve 1/2" FPT x 1/2" FPT 
3	1812702	Line Relief Valve (550PSI) 
4	11529090	Line Strainer 1/2"
5	11635511	PB Regulator 1/2" 450 psi
6	2010064	Pressure Gauge (0-600 PSI) 
7	11627651	5-Way Valve 
8	11018142	Cyl-Tel Gauge 
9	11208931	Check Valve 1/2" WOG

ITEM	PART NO.	DESCRIPTION
10	11385111	Relief Valve (500PSI) 
11	11526622	Rupture Disk (700PSI) 

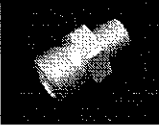
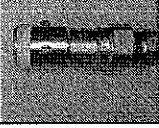
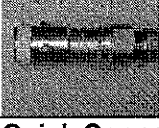
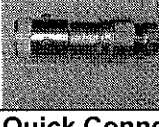
**PERMA-CYL 2000 VHP STANDARD
PRODUCT CONNECTIONS:**

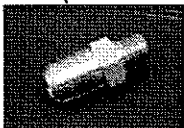
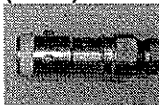
ITEM	PART NO.	DESCRIPTION
	4010022	Outlet 3/8" MPT (INERT) 
	4010012	Outlet 3/8" MPT (OXY) 
	10873809	Quick Connect Fill Fitting (ARG) 
	10873796	Quick Connect Fill Fitting (OXY) 
	10873817	Quick Connect Fill Fitting (NIT) 
	10582833	Quick Connect Fill Fitting (CO2) 
	1110122	Connection 1/2" ODT x 1/2" (45° Flare-Inert) 
	1110912	Connection 5/8" ODT x 1/2" (45° Flare-OXY) 
	10873809	Quick Connect Fill Fitting (ARG) 

Description	2000 Liter VHP Pallet Base
Capacity (liters)	Gross 2,042 Net 1,945
MAWP	psig 500 bar 34.5
Design Spec	ASME
Storage Capacity <i>Nitrogen</i>	SCF 47,847 Nm3 1,257
<i>Oxygen</i>	SCF 59,089 Nm3 1,553
<i>Argon</i>	SCF 57,786 Nm3 1,519
Thermal Performance <i>(NER%/Day)</i>	N 1% O2 - Ar 0.62%
Gas Delivery Rate	SCF/H 2,000 Nm3h 52.4
Dimensions <i>Diameter</i>	in 48 mm 1,219
<i>Tare Weight</i>	lbs 4,900 Kg 2,222
<i>Height</i>	in 116 mm 2,946