



Integra E-Z
Oxygen Concentrator
Service Manual

P/N 2917 Rev E - F
Dec 2011



TABLE OF CONTENTS

1. INTRODUCTION	3
1.1. <i>Explanation of Terms</i>	3
1.2. <i>Definitions.....</i>	3
1.3. <i>Introduction to the ATF</i>	3
1.4. <i>Basic Mechanical Layout</i>	5
1.5. <i>Theory of Operation</i>	5
2. SET-UP AND OPERATION	8
2.1. <i>The proper location.....</i>	8
2.2. <i>Air intake filter.....</i>	8
2.3. <i>Control Panel Display.....</i>	8
2.4. <i>Plug the unit in.</i>	8
2.5. <i>Starting the Integra E-Z.....</i>	9
2.6. <i>Service Mode.....</i>	10
3. MAINTENANCE	9
3.1. <i>Cleaning air intake filter</i>	11
3.2. <i>Scheduled Preventive Maintenance</i>	12
4. TEST PROCEDURES	13
4.1. <i>Unit Test Procedure - Preferred Method</i>	13
4.2. <i>Unit Test Procedure-Alternate Method.....</i>	14
4.3. <i>Alarm Verification Test.....</i>	14
5. TROUBLESHOOTING.....	15
5.1. <i>Alarm Conditions.....</i>	15
5.2. <i>Unit fails to start</i>	17
5.3. <i>Unit tries to start but shuts down alarming.....</i>	17
5.4. <i>Unit does not produce adequate oxygen flow.</i>	18
5.5. <i>Unit starts but shuts down after a short period of operation.....</i>	18
5.6. <i>Compressor pressure relief valve actuates</i>	18
5.7. <i>Compressor Noisy</i>	19
5.8. <i>Trouble Shooting Guide for Integra E-Z units.....</i>	20
6. REPAIR PROCEDURES	23
6.1. <i>Removal and installation of covers</i>	23
6.2. <i>Removal and installation of the POD Assembly.....</i>	23
6.3. <i>Printed Circuit Board Assembly (PCBA) Replacement Procedure.....</i>	24
6.4. <i>Removal and installation of the ATF module.....</i>	26
6.5. <i>Removal and installation of the Compressor Assembly.....</i>	27
6.6. <i>Compressor Top-End rebuild</i>	29
7. INTEGRA E-Z 5L SPECIFICATIONS	31
8. INTEGRA E-Z 7L SPECIFICATIONS	32
9. INTEGRA E-Z 10L SPECIFICATIONS	33
10. PART NUMBERS	34
10.1. <i>Preventive Maintenance Parts.....</i>	34
10.2. <i>Recommended Spare Parts Inventory</i>	34
11. SEQUAL ADDRESS AND WEBSITE INFORMATION.....	35

1. Introduction

SeQual = Chart SeQual Technologies Inc.

1.1. Explanation of Terms



WARNING:

Indicates the possibility of injury to the patient, operator, or technician if accompanying procedures or explanations are not adhered to.



CAUTION:

Indicates the possibility of damage to the device or equipment if procedures are not followed.

NOTE:

Places emphasis on an operating characteristic or important consideration.

1.2. Definitions

ATF[®] (Advanced Technology Fractionator) – The term used to describe the oxygen concentrating module used in SeQual products.

ESD (Electro-Static Discharge) – The effect of small static electrical charges on printed circuit boards and components.

LPM (Liters Per Minute) – typically referring to oxygen flow rate

OM (Oxygen Monitor) - Integra concentrators can be ordered with an integrated oxygen monitor. When specified, a procedure may apply only to OM equipped units.

POD Assembly – Subassembly consisting of the front panel and user interface components including the printed circuit board and oxygen-monitoring device.

Product/Product flow – Refers to the oxygen being produced.

Rated Flow - The flow rate for which that model of Integra was designed to operate as a maximum continuous rate. The rated flow of an Integra E-Z 5 is five liters per minute. The rated flow of an Integra E-Z 7 is seven liters per minute and Integra E-Z 10 is ten liters/minute.

Upgraded – It is the policy of SeQual Technologies to incorporate certain design improvements into machines, which have been returned to the factory for inspection and/or repair. References in this manual to serial numbers indicates that the particular feature or function has been incorporated beginning with that serial number, and is being incorporated on upgraded machines.

1.3. Introduction to the ATF

The SeQual Advanced Technology Fractionator (ATF[®]) module eliminates many of the parts found in conventional pressure swing adsorption oxygen concentrators. It has been designed and constructed to provide years of trouble free service. A quick inspection will reveal the absence of the product tank, pressure regulator, and solenoid manifold found in conventional two-bed concentrators. The functions of these devices are replaced by a single rotating valve, which ports gas movement within the ATF module.

The ATF module utilizes twelve sieve beds and a patented rotary valve to produce a constant flow of oxygen. A small electric motor and reduction gear mounted on the ATF module turns the valve. As the valve rotates, compressed air is channeled to the beds, resulting in four of the beds producing oxygen, four beds are static, and four beds are purging. The oxygen is collected in the product head and is then routed through the pod assembly for patient use. Purge gasses are expelled through two integral mufflers in the ATF base, characterized by a soft, rhythmic “breathing” noise, which can be heard when operating the unit with the covers removed.

CAUTION:



There are no field serviceable components in the ATF assembly. Any attempt to open the module, without the express written consent of SeQual Technologies, will result in module contamination and will void the warranty.

The ATF product flow/pressure is self-regulating by matching compressor size (pressure and volume of flow) to the rated flow of a particular ATF module. Fixed orifices within the module regulate oxygen used as sieve bed purge gas. No adjustments of any type are required in the field. Full concentration is usually achieved within three (3) to ten (10) minutes of turning the unit on, therefore a 10-minute warm up period is recommended prior to conducting concentration tests for diagnostic purposes..

Gas balance is maintained by controlling the flow rate on the POD assembly to operate the unit within its design range. If the product flow is set beyond this design range, there will be insufficient oxygen available to completely purge the beds and concentration will drop. Conversely, if there is extremely low flow (less than 0.5 LPM) more oxygen is purging and a build-up of inert argon gas will occur, which will reduce overall concentration readings.

As with any mechanical device, certain precautions must be observed in order to maintain the unit properly. By familiarizing themselves with several basic principles of ATF operation, technicians will be able to rapidly diagnose problems, effect repairs and return the concentrator to service.

Always apply voltage to the gear motor assembly prior to introducing airflow to the ATF. Check that the shaft visible on the top of the gearbox is rotating. Some grease run-out in this area is typical, especially in units that have had long, continuous service. Wipe the area and mark the drive shaft with a marker to assist in detecting rotation. Minor gear mesh noise is acceptable, but any inconsistent, jerky, or intermittent motion is not normal. Rotation should be smooth.

Always cap or plug the ATF oxygen outlet and air inlet ports when it is not installed or when the hoses are removed. Even short duration exposure to moisture-laden air can have an adverse effect on ATF performance.

Never operate an ATF beyond its rated flow capacity. Ensure that the Integra flow selector knob or an external flow meter properly limits the product flow rate. An ATF designed to deliver 5 liters per minute (LPM) of flow will rapidly suffer performance loss if operated at 6 LPM. Within a short period of time, this performance loss can become permanent.

Never apply compressed air flow to an ATF with a damaged, missing, or malfunctioning gear motor assembly. Even a few minutes of flow without valve rotation can severely and permanently damage the module.

1.4. Basic Mechanical Layout

The Integra E-Z family of oxygen concentrators shares the same basic components and layout, consisting of the compressor, ATF module, and POD assembly. These components are mounted to the base and center frame and are housed in a two-piece cover. Although the plastic components are common to all the Integra E-Z concentrators, refer to the appropriate model data sections concerning parts replacement.

The Integra E-Z Oxygen Concentrator is manufactured in the following variations:

DESCRIPTION	115V / 60 Hz	220-240V / 50Hz
INTEGRA E-Z 5 LPM		6323A EURO
INTEGRA E-Z 5 LPM OM		6323A-OM EURO
INTEGRA E-Z 7 LPM	6323A-7	
INTEGRA E-Z 7 LPM OM	6323A-OM-7	
INTEGRA E-Z 10 LPM	6323A-10	6323A-10 EURO
INTEGRA E-Z 10 LPM OM	6323A-OM-10	6323A-OM-10 EURO

User Controls are located on the front panel of the POD assembly. On/Off button, “Plus”(+) and “Minus”(-) flow rate control buttons, Service button (located behind the No Smoking logo), and the Flow Indicator LCD display.

1.5. Theory of Operation

1.5.1 Air/Product flow

Ambient air is pulled in through the cabinet inlet filter. A cooling fan in the base expels hot air through an opening in the bottom of the case. The compressor inlet filter and muffler assembly, mounted on the center frame above the compressor, provides sound suppression and filtered air to the compressor via a clear feed tube. Compressed air from the compressor runs through a heat exchanger coil and into the inlet barb of the ATF module. Oxygen from the product barb is routed to the pod assembly.

The POD assembly provides electrical power, oxygen flow control, flow rate indication, and various monitoring functions depending on model. The oxygen outlet port is equipped with a DISS fitting for connection of appropriate accessories such as a humidifier, cannula, etc.

1.5.2 Electrical

A two-prong plug can be inserted into any standard outlet of the appropriate voltage. All Integra E-Z concentrators are double insulated and require no grounding.

WARNING



Do not modify or otherwise tamper with the electrical harness or attached components without the express, written consent of SeQual Technologies. Doing so could result in the loss of double insulation protection and create a potential hazard.

Line voltage is connected to a printed circuit board mounted in the POD assembly. Transformers on the board reduce line voltage to low voltage for circuit board control, flow

control and monitoring functions. Circuit traces route power to the cooling fan, ATF gear motor, and compressor.

WARNING



Line voltage is present at the circuit board at all times when the unit is plugged into a wall outlet. Unplug the concentrator prior to performing maintenance or repairs in this area.

CAUTION:



Do not touch or attempt removal of the circuit board without ensuring that all Electro-Static Discharge (ESD) procedures and controls are in place. Damage to components on the printed circuit board can result in a failure in performance of the device.

The push button On/Off switch is of the momentary contact, which is read by microcontroller on the main board and turns on the power to activate cooling fan, ATF gear motor and compressor. . . A Pure Sine wave electrical signal for Mains power is required to operate the Integra only. Subsequently, a Modified Sine Wave for Mains power is not recommended.

A power management feature has been incorporated to improve protection to the user in the event of a momentary power failure. In the event of a power interruption, the unit will alarm as normal for a power loss. A 9V battery provides back-up power for alarm circuit. The unit will resume operating twenty seconds after the initial interruption, unless it has been turned off during the power interruption.

Integra E-Z family of oxygen concentrators incorporates a closed-loop feedback flow control valve, eliminating the need for the user to adjust or tweak the flow on the unit more than the initial setting. This is accomplished by the integration of a flow and concentration measurement system (OM models only) in a new control system. From the patient point of view, the system will operate in a “set and forget” mode where a desired flow rate is set (using up/down arrows and a display to indicate the target flow rate) and the system automatically adjusts the internal flow control valve to provide that flow to the patient, regardless of what accessories are attached to the oxygen concentrator.

The OM models also incorporate circuitry on the printed circuit board which are used in conjunction with the ultrasonic measurement flow tube and uses the timing of the speed of sound in the gas mixture to calculate the percentage of oxygen present in the gas stream. A timing circuit on the board prevents the low oxygen alarm from sounding during the warm-up cycle (a maximum of 10 minutes).

The Integra E-Z oxygen concentrator does not utilize a conventional circuit breaker. A separate “current-sense” transformer mounted on the printed circuit board continuously monitors the current being drawn by the compressor. This sensing feature will turn off the concentrator to prevent excessive current draw in the event of a component failure or other abnormal high demand condition. There is nothing to reset. Once the unit detects the abnormal power condition it will shut-down and alarm. The user will only need to turn off the unit and turn it back on and assuming the power has returned to normal and there is no additional fault it will

start running. In addition the Integra E-Z has two fuses. The primary fuse F2 (service technician replaceable fuse, see Section 10 for spare parts) is used as a back-up to the current-sensing system and will prevent excessive current draw by the compressor. Another non-replaceable fuse, F1, provides protection in the event of a transformer failure.

A thermal cut off switch, located in the bottom of the base in front of the compressor, acts as a thermal circuit interrupt. In the event that the internal cabinet temperature rises above approximately 140 degrees Fahrenheit (60 degrees C), the switch will open, this will be detected by the current sense feature and shut the unit off and alarm. The switch will automatically reset when the cabinet temperature returns to normal operating range. On the Integra E-Z models once the thermal switch closes again the unit will not automatically turn back ON after temperature returns to normal. It will require user to address the cause of overheating (unit covered by blanket or similar issue) and then press the On/Off button to continue use of the oxygen concentrator.

2. Set-up and Operation

2.1. The proper location.

Locate the concentrator in a well-ventilated space that provides adequate airflow. Ensure that furniture, draperies or clothing will not impede air circulation. The Integra requires 6 air exchanges per hour to properly ventilate. Avoid placing the unit over a floor heat register or against a baseboard heating system.

2.2. Air intake filter.

The air intake filter should be inspected and cleaned Weekly. It should be clean and free of debris. Refer to Routine Maintenance Section.

2.3. Control Panel Display

The Control Panel and buttons is shown in the figure below.

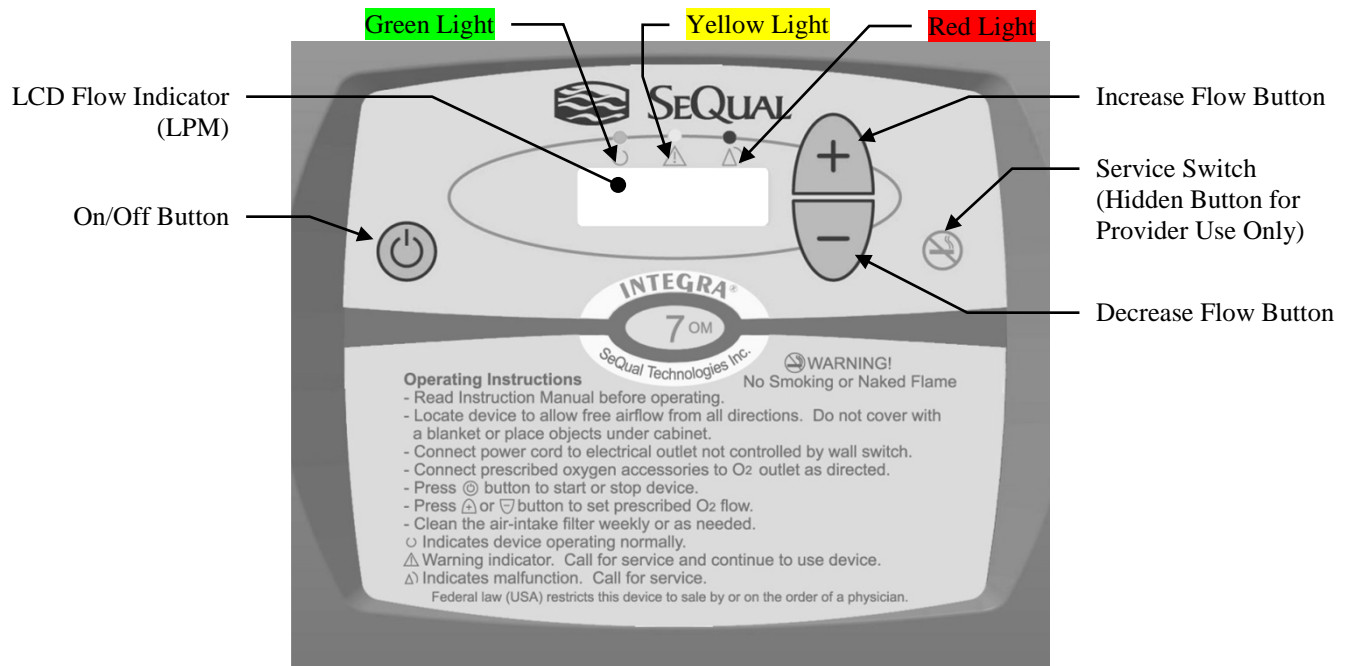

2.4. Plug the unit in.

The backlight on the Flow Indicator LCD display will turn ON indicating the unit is energized and ready for use.



WARNING:

Do Not connect to an extension cord or electrical outlet controlled by a switch. No other appliance should be plugged into the wall outlet. Voltage requirements are marked on the label on back of unit.



Flow Rate Shown?	Green Light	Yellow Light	Red Light	Audible Alarm	Unit State	Operating Condition
No	Off	Off	Off	Off	Not Energized	Unit not running / Flow Indicator Display Not Lit
No	Off	Off	Off	Off	Energized	Unit not running / Flow Indicator Display Lit

2.5. Starting the Integra E-Z

2.5.1. Push the On/Off button and verify the unit Start-Up Sequence

Allow the unit to warm-up and stabilize (approximately 2 minutes but allow up to 10 minutes). Adjust the flow using "+" and "-" buttons. A shorter warm-up will occur at lower flow rates.

NOTE:

The Integra E-Z flow indicator sets the target flow rate desired by the patient. The installation of humidifiers or other devices can cause a back pressure on the unit therefore it is recommend that the flow rate be set prior to attaching accessories to the concentrator. After an initial startup or after a power interruption the unit may automatically reduce the flow rate briefly before returning to the set flow rate.

2.5.2. Start-up Sequence OM units

On initial start-up Integra E-Z units light the Green, Yellow and Red LED's with a 3 second beep followed by an intermittent beep for the remainder of the warm-up. As concentration increases to ~70%, the Red LED turns off and the Yellow and Green remain on. When the concentration reaches normal operating range (above 85%), the Yellow LED will turn off as well as the intermittent beep. The Green LED will stay lit indicating normal operation.

2.5.3. Start-up Sequence Non-OM units

On Non-OM start-up Integra E-Z units will light the Green, Yellow and Red LED's with a 3 second beep indicating all alarms indicators are functioning followed by the green LED turning on. The table below shows operating conditions for Integra E-Z Oxygen Concentrators:

Flow Rate Shown?	Green Light	Yellow Light	Red Light	Audible Alarm	Unit State	Operating Condition
Yes	On	On	On	On for 3 seconds	Started Running	Unit is Starting
Yes	On	On	On	Periodic Beep	Running	Unit is warming up*
Yes	On	On	Off	Periodic Beep	Running	
Yes	On	Off	Off	Off	Running	Normal Operating Condition
Yes	Off	On	Off	Periodic Beep	Not Running	Unit turned On/Off/On Quickly

* These conditions are displayed only on units equipped with oxygen monitor.

2.5.4. Attach required tubing, humidifier and additional accessories as prescribed.

CAUTION:



Use of downstream or external flow control device is not recommended. The Integra E-Z will attempt to control the flow rate to the target flow set on the indicator. If the unit cannot control to this flow rate an alarm indication will occur and potential damage may occur to the unit.

CAUTION:



Use of certain administration accessories not specified for use with this oxygen concentrator may impair the performance.

2.6. Service Mode:

To Enter Service Mode press the Hidden Switch (located behind the top No-Smoking symbol) and either the “+” or “-“ button for a minimum of 2 seconds. To Exit Service Mode press the Hidden Switch and either the “+” or “-“ button again or it will exit by itself after 10 seconds.

2.6.1. Checking Hourmeter (provider use only)

After entering Service Mode use the “+” or “-“ buttons to scroll through the options until the hourmeter reading is displayed HXXXXX.X

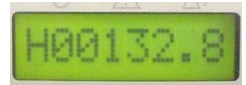

2.6.2. Checking Battery Level (provider use only)

After entering Service Mode use the “+” or “-“ buttons to scroll through the options until the software revision displayed. 5 Solid Bars = Full Battery and 0 Solid Bars = Depleted Battery. Recommended battery replacement at 2 Solid Bars (See Maintenance Section).

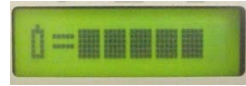

2.6.3. Enable or Disable Battery Level Alarm (provider use only)

After entering Service Mode use the “+” or “-“ buttons to scroll through the options until the battery symbol is displayed. If the battery alarm is disabled you will see a “D”, this is how the unit is shipped from the factory. If the battery alarm is enabled you will see an “E”. To change the alarm status press only the Hidden Switch while in Service Mode. The Battery Alarm will be triggered at 2 Solid Bars.



2.6.4. Checking Software Revision (provider use only)

After entering Service Mode use the “+” or “-“ buttons to scroll through the options until the software revision displayed SW=X.XX



3. Maintenance

Routine Maintenance: Routine maintenance consists of cleaning the air inlet filter at a weekly interval to keep the unit functioning properly. Once the filter is cleaned, dried, and re-installed. The user can easily achieve this maintenance. When other than routine maintenance is needed, contact an Authorized Service Center for a Return Authorization #.

NOTE: Plug the Integra in and run the device for 1 - 2 hours on minimum of a monthly basis.

Annual Maintenance: An Annual Internal Filter PM is required for proper operation of the Integra.

3.1. Cleaning air intake filter

- 3.1.1 Once a week, the air intake filter located on top of the unit must be cleaned.
- 3.1.2 Remove the filter from the cabinet.
- 3.1.3 Wash the filter in warm water using a mild detergent solution.
- 3.1.4 Rinse the filter thoroughly and squeeze out the excess water.
- 3.1.5 Allow the filter to air dry.



CAUTION:

The filter should be completely dry before using it again as excess moisture may impair the proper operation of the oxygen concentrator.

- 3.1.5 Re-insert the filter in the cabinet.



CAUTION:



The air intake filter should be replaced Annually. If the Oxygen Concentrator is used in a dusty environment, the filter may need to be cleaned or replaced more often. Do Not operate the Oxygen Concentrator for more than 30 minutes without a filter installed

3.2. Scheduled Preventive Maintenance (Use PN 4542-SEQ “Annual PM Kit”- once every 12 Months(Annually) or as needed)

3.2.1. Replace the 9V Battery once every 12 Months(Annually) or when Battery Level is at 2 Bars:

Replace the 9V battery(8098-SEQ) annually or when the Battery Indicator Level is at 2 Bars. To check this, enter Service Mode as described in Section 2.6.



3.2.2. Replace the Compressor Inlet Filter once every 12 months(Annually) or as needed:

Replace the compressor intake filter annually or as needed depending upon the environment in which the concentrator is operating. The compressor intake filter can become clogged depending upon the amount of contaminants in the air (smoke, dust, dirt, pollen, etc.) and may need to be changed more frequently. Refer to the Troubleshooting Guide for signs of a clogged filter and refer to the Replacement Parts section for the correct compressor intake filter.



**REPLACE
FILTER**

CAUTION:



Operation of the oxygen concentrator with a clogged compressor intake filter will reduce the performance of the unit and can lead to system damage and premature failure.

3.2.2.1. Open the hook and loop straps holding the Filter on the Filter/Muffler assembly. Hold the unit and twist and pull the filter to remove it from the muffler. Insert outlet tube on Filter (2607-SEQ) into the hole on the Muffler. Rotate the filter so that the two parts are lined up across the top length and side. Firmly push the Filter into the Muffler until the two parts touch, and re-secure the velcro loop strap.

3.2.2.2. In addition ensure the free end of the PVC Tubing is on the compressor Air Inlet Fitting barb.

NOTE:

The most common cause of low concentration and eventual system failure is a dirty or clogged compressor inlet filter. The environmental conditions in which the unit is operated determine the effective filter life.

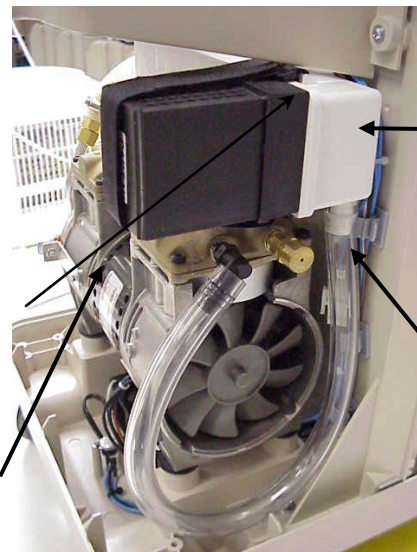

**Muffler
Attached to
Center Frame**

**PVC Tubing
attached to
Muffler**

**Loop Strap securing
filter to muffler**

- 3.2.2.3. Verify proper oxygen concentration (refer to spec chart pg# 31, 32, or 33). The concentration should be a minimum of 88% at maximum rated flow. Refer to the troubleshooting section if this concentration is not met. While monitoring the concentration, verify that the LED's function properly on OM equipped units during start-up.
- 3.2.2.4. Clean inside the unit, as needed using a small vacuum cleaner to remove any accumulation of dust or debris, prior to attaching the covers.

3.2.3 Replace the HEPA filter once every 12 months(Annually) or when visibly dirty.

- 3.2.3.1 Remove the existing clamp or cut off the existing cable tie on one side of the HEPA filter.
- 3.2.3.2 Disconnect tubing from both sides of HEPA filter.
- 3.2.3.3 Plug in new HEPA filter.

Note: If new HEPA filter still shows IN on input, and OUT on output, or an arrow shows direction of the flow, make sure that HEPA Filter is installed following the direction of the flow, which is from the ATF to the POD. Flow is upwards in the picture below.

- 3.2.3.4 Apply a new cable tie or clamp around the tubing.

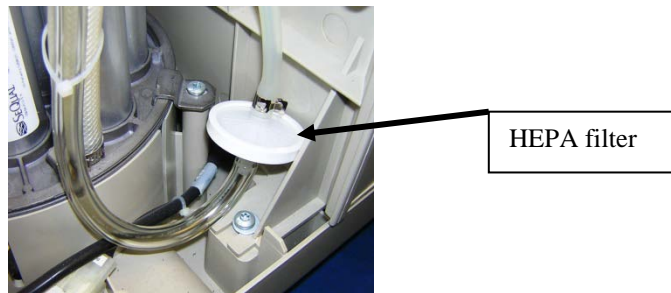

4. Test Procedures

4.1. Unit Test Procedure - Preferred Method

It is recommended that the Integra E-Z be tested for oxygen concentration and flow performance periodically. The factory recommended Test Setup for the Integra E-Z is shown on the following diagram. Oxygen monitors may or may not have an internal pump to draw samples of Oxygen to be measured. Placement of the Oxygen Monitor in the test circuit depends whether they have an internal pump. Only one Oxygen Monitor is needed though.

- 4.1.1 Connect the circuit per the diagram shown on the next page.
- 4.1.2 Turn the concentrator on and allow it to warm up at one-half of its rated flow setting (approximately 5 minutes).
- 4.1.3 Set the target flow on the Integra E-Z to the maximum rated flow, 5 LPM for Integra Five, 7 LPM for Integra Seven, 10 LPM for Integra Ten and oxygen monitor flow valve to low flow settings.
- 4.1.5 Allow the unit stabilize (approximately 10 minutes).

- 4.1.6 Verify the O₂ concentration, O₂ flow rate and O₂ pressure are within specification (See Section 7, 8 or 9 depending on the model).

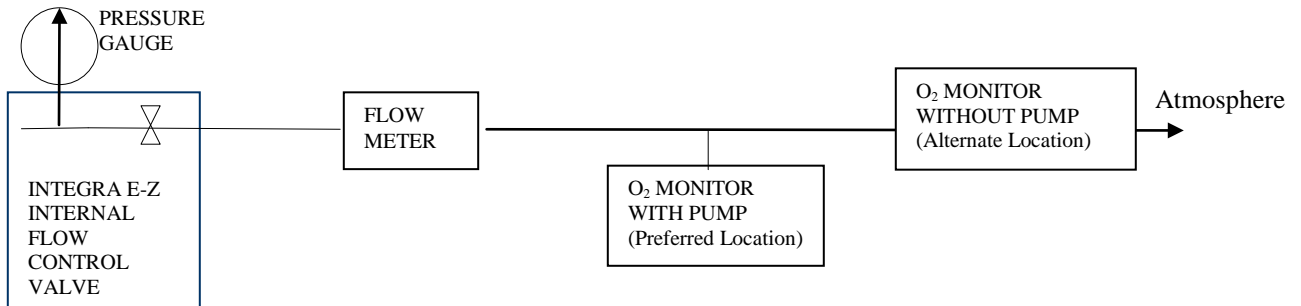

Factory Recommended Test Setup to verify performance of Oxygen Concentrator

NOTE:

For Integra E-Z units an external flow valve will not perform adequately due to the flow control circuit. In this situation the pressure gage should be plumbed into the system at the HEPA filter, inside the unit. For the O₂ monitor without pump, it can be installed after the outlet of the external flow meter or at the outlet fitting (see Alternate Method 4.2) to force the O₂ gas through the O₂ analyzer (check to ensure the O₂ analyzer can handle the total flow rate).

4.2. Unit Test Procedure-Alternate Method

Attach a calibrated Oxygen Monitor to the DISS block in accordance with Oxygen Monitor manufacturers recommendations. It is important to not obstruct the flow, as this will affect the Integra’s actual concentration (lower flow will typically increase the oxygen concentration)

NOTE:

The flow control circuit on the Integra E-Z is designed to properly deliver oxygen flow rates during normal usage. Some sensing equipment may restrict the actual flow rate below what the Integra E-Z can provide and provide inaccurate concentration readings. A highly blocked oxygen outlet will result in lower oxygen concentration due to a build-up of argon gas.

4.3. Alarm Verification Test

Verify the Alarm Indicators (buzzer and lights) are functioning properly by confirming the proper start-up sequence for the unit per sections describe below.

4.3.1. Start-up Sequence OM units

On initial start-up Integra E-Z units light the Green, Yellow and Red LED’s with a 3 second beep followed by an intermittent beep for the remainder of the warm-up. As concentration increases to ~70%, the Red LED turns off and the Yellow and Green remain on. When the concentration reaches normal operating range (above 85%), the Yellow LED will turn off as well as the intermittent beep. The Green LED will stay lit indicating normal operation. The



table on the next page shows the normal start-up operating conditions for Integra E-Z Oxygen Concentrators.

4.3.2. Start-up Sequence Non-OM units

Non-OM Integra E-Z units start-up with the Green, Yellow and Red LED's lit and a 3 second beep indicating all alarms indicators are functioning followed by the green LED turning on. The table below shows the normal start-up operating conditions for Integra E-Z Concentrators.

Flow Rate Shown?	Green Light	Yellow Light	Red Light	Audible Alarm	Unit State	Operating Condition
Yes	On	On	On	On for 3 seconds	Started Running	Unit is Starting
Yes	On	On	On	Periodic Beep	Running	Unit is warming up*
Yes	On	On	Off	Periodic Beep	Running	
Yes	On	Off	Off	Off	Running	Normal Operating Condition
Yes	Off	On	Off	Periodic Beep	Not Running	Unit turned On/Off/On Quickly

* These conditions are displayed only on units equipped with oxygen monitor.

5. Troubleshooting

5.1. Alarm Conditions

Flow Rate Shown?	Green Light	Yellow Light	Red Light	Audible Alarm	Unit State	Operating Condition
Yes	Off	Flashing	Off	Off	Running	Oxygen Concentration Below Normal Level *
						O ₂ Flow Rate Not Correct 10% off target flow
Yes	Off	Off	Flashing	On	Running	Oxygen Concentration Abnormal Level * ¹
						O ₂ Flow Rate Abnormal 30% off target flow ¹
Yes	Off	On	Off	Off	Running	Button Stuck
Yes	On	On	Off	Off	Running	9V Battery Low Voltage (if enabled)
No	Off	Off	Flashing	On	Not Running	Unit is overheating
						Compressor Malfunction
						Power Interruption
No	On or Off	On or Off	On	On	Running	System Malfunction ^{1,2}

* These conditions are displayed only on units equipped with oxygen monitor.

¹ Call the SeQual Customer Service if abnormal conditions are detected and cannot be remedied.



² During System Malfunction condition the Green and Yellow lights may be On or Off.

5.1.1 Flashing RED LED, Steady alarm sounding.

- 5.1.1.1. Power Interruption External to Unit - Current from wall outlet interrupted. Push the On/Off button to stop alarm. Check for open household fuse or actuated household circuit breaker. Restore power.
- 5.1.1.2. Power Interruption Internal to Unit - Thermal switch activated. Push the On/Off button to stop alarm. Check for adequate clearance (refer to the Operation and Set-up section).
- 5.1.1.3. Power Interruption Internal to Unit – Compressor Malfunction (See Section 5.5 or 5.9 for compressor troubleshooting).
- 5.1.1.4. Power Sags and Surges – Simulating a circuit breaker popped due to a high or low current. Correct the source of the power problem. Push the On/Off button to stop alarm (the unit resets itself if the source of the inconsistent power is resolved). Wait for at least 20 seconds and push Off/On button to restart the Integra E-Z.
- 5.1.1.5. Oxygen flow rate being measure and controlled by the Integra E-Z doesn't agree with flow set on the front panel by more or less than 30% of target flow rate. If alarm persists, check for kinked or blocked tubing inside or outside the unit, or for leaks between the flow meter and the control valve. For further investigation check to see if the flow control valve is stuck in the open or closed position, or doesn't adjust the flow.

5.1.2. Solid YELLOW LED, No alarm

- 5.1.2.1. The concentrator has detected a stuck button. The button determined to be stuck will not function. To locate which button is stuck push the buttons one at a time and see which one does not react. If the On/Off button is stuck unplug the power cord from the wall to turn the unit off.

5.1.3. YELLOW and GREEN LED Illuminated Only, No alarm.

- 5.1.3.1. The concentrator is indicating that the 9V Battery has a low voltage level. This is signaling the technician or patient that the Battery Level is at 2 Bars and the battery needs to be replaced.

NOTE:

This Alarm Indicator is shipped from the factory as “D” Disabled. The provider may chose to turn this feature on as described in the Service Mode Section 2.6.3, and if this feature is disabled and the battery is drained the unit will not be able to alarm in the event of a power failure.

5.1.4. Flashing YELLOW LED, No alarm.

- 5.1.4.1. Oxygen flow rate being measured and controlled by the Integra E-Z doesn't agree with flow set on the front panel by more than 10%.. If alarm persists, check for kinked or blocked tubing inside or outside the unit, or for leaks between the flow meter and the control valve. For further investigation check to see if the flow control valve is stuck in the open or closed position, or doesn't adjust the flow.

5.1.5. OM Models - YELLOW LED illuminated. Concentration is below 85%

- 5.1.5.1. Check flow rate setting - flow set too high will reduce concentration. Allow 5 minutes for flow to stabilize at lower setting, green LED should illuminate.
- 5.1.5.2. Filter clog- check cabinet inlet filter and compressor inlet filter (refer to Routine Maintenance section).



- 5.1.5.3. Unit out of calibration- perform concentration check.
- 5.1.5.4. Unit overheating- efficiency of the adsorption process is reduced if cabinet temperatures are elevated. Ensure adequate ventilation (refer to the Operation and Set-up section)
- 5.1.5.5. Compressor worn - check compressor output.
- 5.1.5.6. ATF worn – check unit with another equivalent ATF.

5.1.6. OM Models - Red LED Flashing, Steady alarm. Concentration below 70%

- 5.1.6.1. Push the On/Off switch to silence alarm. Attempt restart and check for the same conditions as outlined above (flow setting, filter clog, etc).
- 5.1.6.2. Check the unit interior for loose or disconnected oxygen tubing.
- 5.1.6.3. Disconnect external attachments and run Integra. Check for fluctuations (+1 LPM). If fluctuations present, contact SeQual Customer Service.

NOTE:

On initial start-up, a timing circuit in the printed circuit board prevents the alarm from sounding while the unit stabilizes. The alarm will not sound until this 10 minute warm-up time delay is complete. During this time an intermittent beep will sound alerting the user that the Integra E-Z is warming up.

5.2. Unit fails to start

NOTE:

All Integra E-Z models contain a power management feature that will automatically restart a unit that experiences a power interruption. If the power interruption was very short and the unit was not turned off or the unit was turned off and on quickly - there will be a delay in starting. The Yellow Indicator light will be on and an intermittent beeping sound will be heard. Wait 20 seconds. Unit will start automatically.

- 5.2.1. If unit doesn't start, first check if Flow Indicator (LCD Display) backlight is turned on (in bright daylight this may be a little difficult to detect so cup your hand around the display area to determine if this light is on). If it is off follow next steps.
- 5.2.2. Check that unit is plugged in.
- 5.2.3. Check that the unit is not plugged into an outlet controlled by a wall switch that is off.
- 5.2.4. Check that the fuse or circuit breaker controlling the outlet is intact/on.
- 5.2.5. Check the main fuse on the circuit board is not blown. Replace this fuse if it is blown.
- 5.2.6. Check the compressor capacitor is not shorted or blown. Replace if needed.

5.3. Unit tries to start but shuts down alarming

NOTE:

A unit which has been exposed to temperatures below 50°F for an extended time may have cold-soaked the compressor piston sleeves, causing the sleeves to contract. This will be indicated by a squealing sound or failure of

the compressor to start. Allow the unit to come up to room temperature before operating.

- 5.3.1. Attempting to start the unit with air pressure already in the system will cause the compressor to stall. As stated in the Note in section 5.2 a time delay feature has been added to prevent the unit from starting until the pressure in the system has bled down.
- 5.3.2. Unplug unit, open covers and check to ensure the compressor can be rotated by turning the fan by hand. If this is difficult to do then there is a compressor malfunction and the compressor must be serviced or replaced.



Warning: Ensure the unit is unplugged before testing this operation.

Warning: Use a glove or similar hand protection to rotate the fan, the plastic edges can be sharp and cut your hand.

- 5.3.3. Check for damage to the traces on the circuit board. Failure of an internal component can cause excessive power draw. This will typically result in burn marks adjacent to the eight-pin connector that can be observed with the back cover removed. Contact SeQual Customer Service for assistance.

5.4. Unit does not produce adequate oxygen flow

- 5.4.1. Check to verify that the target flow set point is correct
- 5.4.2. Check for a blocked humidifier bottle (if one is being used). Tip: Remove for testing.
- 5.4.3. Check for external kinked, flattened, or blocked tubing or accessories (remove accessories from DISS fitting and see if adequate flow is coming out of the DISS fitting).
- 5.4.4. Remove covers and check for internal kinked, flattened, or blocked tubing.
- 5.4.5. Check the inside of the unit for loose or disconnected tubing.
- 5.4.6. Check for operation of the flow control valve (open and close the valve by pushing the “+” and “-“ buttons and look for or feel the valve moving/stepping).
- 5.4.7. Check for air flow blockage in elbow-muffler connection. Replace muffler if necessary.

5.5. Unit starts but shuts down after a short period of operation

- 5.5.1. Re-start the unit and check for adequate airflow (refer to Operation and Set-up).
- 5.5.2. Check for cooling fan operation. Air should be blowing out of the bottom of the cabinet and can be felt by putting a hand under the base. If no Air flow is present:
- 5.5.3. Unplug the unit, remove the covers and check cooling fan for blockage. Plug the unit back in and check for line voltage at the fan connector. If not present, check to ensure the eight-pin connector (J10) is securely connected at the printed circuit board. If the connection is “good”, then replacement of the printed circuit board or POD assembly may be required. Contact SeQual Customer Service for assistance.

5.6. Compressor pressure relief valve actuates

- 5.6.1 Turn unit ON and check for valve rotation on the ATF. Loosen the four clamp screws attaching the ATF to the base, sufficiently to lift the ATF out of the nest to rotate the ATF onto its side being careful not to hit the gearmotor on the base. It is not necessary to remove any tubing or hoses. Lay the ATF on its side on the base and look at the gearbox for the drive shaft rotation.

NOTE:

Drive shaft rotation may be difficult to see.
Mark the shaft using a sharpie marker or grease pencil.

- 5.6.2 If the valve is rotating smoothly, test the compressor relief valve (See step 6).
- 5.6.3 If the valve motion is jerky, hesitates, or otherwise displays inconsistent rotation, replace the ATF.
- 5.6.4 If there is no valve rotation, check for AC line voltage on the two-pin connector to the gear motor. If voltage is present, replace the ATF.
- 5.6.5 5.8.5 If no voltage is present, check for loose connections on the eight-pin connector on the PCA board. If continuity check in the harness doesn't detect bad contact, replace the pod or PCA board assembly.
- 5.6.6 5.8.6 To test the compressor pressure relief valve (PRV) the ATF will need to be disconnected from the compressor:
- 5.6.7 Remove the air tube from the air inlet barb on the ATF and attach to the following gauge setup.
- 5.6.8 Install a "T" fitting to the hose from the compressor. At one end of the "T" install a pressure gauge, at the other end install a needle valve (fully open) in series with a flow meter.
- 5.6.9 Start the compressor and slowly increase the pressure by closing the valve. The pressure relief valve should not actuate until 35 (+2) psig.
- 5.6.10 Cycle the PRV a few times to clean out any potential contamination. Test the PRV again to see if it activates at 35 (+2) psig. Replace if it fails.
- 5.6.11 If these steps do not identify the problem, contact SeQual Customer Service for assistance.

5.7. Compressor Noisy

- 5.7.1. Compressor noises can be either a result of vibration being transmitted to the frame or a sign of impending compressor failure. Bearing or piston noise can be localized by holding a long screwdriver on the compressor frame or head while placing your ear against the handle. Noise of this type will not be repairable by rebuilding the compressor; it will need to be replaced.

NOTE:

A unit which has been exposed to temperatures below 50°F for an extended time may have cold-soaked the compressor piston sleeves, causing the sleeves to contract. This will be indicated by a squealing sound or failure of the compressor to start. Allow the unit to come up to room temperature before operating.

- 5.7.2. Noise as a result of vibration transmission can occur if the heat exchanger coil has been deformed due to rough handling. Improper coil spacing can pre-load the compressor spring mounts, transmitting compressor vibration to the frame.
- 5.7.3. Remove the covers and start the unit.
- 5.7.4. Press on the right end of the compressor to see if noise abates.



WARNING:

There are no fan guards on the compressor. Keep fingers clear of the fan blades!

WARNING:



If the compressor has been running for any length of time, the compressor surfaces (especially the metal ones) will be hot and can cause burns. Wear protective gloves as required.

- 5.7.5. If the noise does not go away or increases, gently press on the left end of the compressor.
- 5.7.6. If the noise persists, check for loose hardware. Refer to the Compressor Installation section.
- 5.7.7. If the noise goes away while pressing on one of the compressor ends, the heat exchanger coil will need to be reshaped. If the noise decreased while pressing on the right end, the coil needs to be closed slightly. If the noise decreased while pressing on the left end it will need to be opened slightly.

WARNING:



Do not perform this with bare hands and a unit, which has been running for any period of time. The heat exchanger becomes very hot and can cause bad burns to hands. Wear protective gloves as required.

- 5.7.8. Open or close the coils by gently manipulating with thumbs and fingers. The spacing between the coils should be even. Ensure that none of the coils contact each other. Ensure that the air hose running through the center frame does not touch the sides of the opening.
- 5.7.9. If the noise occurs after the compressor has been removed from the unit and or rebuilt the vibration isolation springs may be forcing the compressor out of its natural position. To remedy this issue look at one end of the compressor and see if it is leaning toward or away from center frame. Rotate the springs to bring the compressor into a neutral position. This will need to be done for all four springs as well as in conjunction with the reshaping the heat exchanger.

NOTE:

A noise free installation requires the compressor to sit on the four springs in a neutral position without any external force pushing it out of position.

5.8. Trouble Shooting Guide for Integra E-Z units

Table 1: Concentrator is not Running

Symptom	Probable Cause	Remedy
Unit won't start Flow Indicator Blank Back Light Off	Power cord not plugged into wall outlet.	Check condition of power cord. Plug in power cord.
	Internal Fuse blown.	Check condition of power cord. Service required.
Audible Alarm Blinking Red Light Flow Indicator Blank Back Light Off	Power cord pulled from wall outlet.	Plug in power cord.
	Power outage.	Push On/Off Button to turn off unit. Push On/Off Button to restart unit when power comes back on.



	No power at wall outlet.	Ensure the unit is not plugged into a wall switched outlet. Check house circuit breaker or fuse - reset or replace as needed.
Audible Alarm Blinking Red Light Flow Indicator Blank Back Light On	Unit overheating	Remove any obstruction(s) from air openings and refer to page 7 "The Proper Location" section.
	Compressor malfunction	Service required.(Call Tech Support).

Table 2: Concentrator Running

Symptom	Probable Cause	Remedy
No oxygen / flow (refer to the alarm indications on Table 3 this section)	Humidifier or tubing blocked or kinked	Clean or replace humidifier and/or tubing. Remove tube kink.
	Air Inlet Filter blocked	Clean air inlet filter. Perform Annual Filter PM.
	Internal component malfunction	Service required. Call Tech Support). 1) Check stepper motor in flow control valve, 2) Check ATF gearmotor turning properly, pressure "in" vs "out"? 3) Check proper pressure from compressor -
Low oxygen / flow (refer to the alarm indications on Table 3 this section)	Restriction in humidifier or tubing.	Repair or replace humidifier as required.
	Air Inlet Filter restricted	Clean air inlet filter, or Perform Annual Filter PM.
	Internal component worn or malfunctioning	Service required.(Call Tech support) or 1) Check System Pressure(at DISS adapter), 2) Replace ATF Assy, 3) Compressor may need rebuilding.
Yellow Light On	Button is stuck	Service required.(Call Tech Support - Replace Pod Assy)
Flow Rate not visible on Flow Indicator Display	LCD malfunction	Service required.(Call Tech Support - Replace Pod Assy)
Audible Alarm Red Light On Flow Indicator Blank Back Light On	System malfunction	Remove power cord from wall outlet. Service required.

Note: If abnormal operating conditions are detected and cannot be remedied, contact SeQual Customer Service.



Table 3: Operation Display Conditions

Flow Rate Shown?	Green Light	Yellow Light	Red Light	Audible Alarm	Unit State	Operating Condition
No	Off	Off	Off	Off	Not Energized	Unit not running / Flow Indicator Display Not Lit
No	Off	Off	Off	Off	Energized	Unit not running / Flow Indicator Display Lit
Yes	On	On	On	On for 3 seconds	Started Running	Unit is Starting
Yes	On	On	On	Periodic Beep	Running	Unit is warming up*
Yes	On	On	Off	Periodic Beep	Running	
Yes	On	Off	Off	Off	Running	Normal Operating Condition
Yes	Off	On	Off	Periodic Beep	Not Running	Unit turned On/Off/On Quickly
Yes	Off	Flashing	Off	Off	Running	Oxygen Concentration Below Normal Level *
						O ₂ Flow Rate Not Correct 10% off target flow
Yes	Off	Off	Flashing	On	Running	Oxygen Concentration Abnormal Level * ¹
						O ₂ Flow Rate Abnormal 30% off target flow ¹
Yes	Off	On	Off	Off	Running	Button Stuck
Yes	On	On	Off	Off	Running	9V Battery Low Voltage (if enabled)
No	Off	Off	Flashing	On	Not Running	Unit is overheating
						Compressor Malfunction
						Power Interruption
						Internal Fuse is Blown
No	On or Off	On or Off	On	On	Running	System Malfunction ²

* These conditions are displayed only on units equipped with optional oxygen monitor(OM).

¹ Call the SeQual Customer Service if abnormal conditions are detected and cannot be remedied.

² During System Malfunction condition the Green and Yellow lights may be On or Off.

6. Repair Procedures



WARNING:

Observe all safety precautions during maintenance. Unplug the unit unless power is required for observation of operation, adjustment, power readings or leak checks.



WARNING:

At the completion of any procedure which disturbs any air or oxygen carrying hose or tube, conduct a leak check of the affected area prior to returning the unit to service.



WARNING:

There are no fan guards on the compressor. Keep fingers clear of the fan blades!

6.1 Removal and Installation of Covers

- 6.1.1 Remove the five screws holding the cover halves together, two in each side and one in the handle.
- 6.1.2 Tilt the front cover forward and lift clear.

NOTE:

Ensure any attachments are removed from DISS adapter fitting.

- 6.1.3 Tilt the back cover rearward and lift clear.
- 6.1.4 Re-install the back cover first by seating the back flange over the base. Ensure that the wiring harness power cord plate is properly seated in the base.
- 6.1.5 Re-install the front cover by aligning the two tabs with the openings in the base. Ensure the front cover seats properly over the POD Assembly. Seat the molded flange over the edge of the rear cover.

NOTE:

Do not allow the tabs to contact the electrical wiring harness.

- 6.1.6 Re-install the five screws. Torque side cabinet screws to 18 inch-pounds. Hand tighten the smaller screw in the handle to snug fit.

6.2 Removal and Installation of POD Assembly

- 6.2.1 Unplug unit from the AC power source. Confirm that Flow Indicator Backlight is off.
- 6.2.2 Remove the covers.
- 6.2.3 Cut the Zip Tie and disconnect the oxygen supply tube coming from the ATF at the HEPA filter. Temporarily plug over the opening (using tape or a cap) in order to keep the filter clean.
- 6.2.4 Disconnect the 9V battery strap.
- 6.2.5 Remove the 8-pin plug (J10) from the circuit board by pressing down on the side catch and pulling gently. It may be necessary to rock the connector slightly.

Cut Zip Tie & Remove

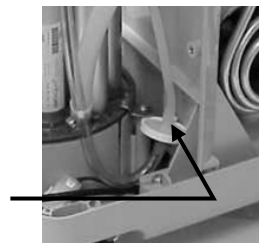

- 6.2.6 Remove the four screw hardware sets that physically attach the POD to the center frame (save them for reinstallation).
- 6.2.7 Installation is conducted in the reverse order. Ensure that the oxygen feed tube is routed through the opening in the center frame to the HEPA filter coming from the ATF. Torque the nuts to 8 inch-pounds.

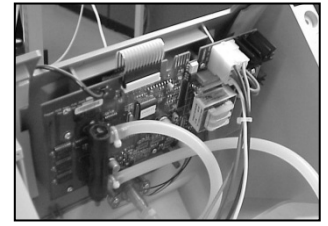

NOTE:

Ensure the feed tube is not blocked, crimped or kinked upon completion of the installation or the unit will alarm for low oxygen flow after the 10-minute warm-up cycle is complete.



- 6.2.8 Start the unit and check for leaks at tubing connector to oxygen HEPA filter.
- 6.2.9 6.10.9 Shut down unit and re-install covers.

6.3 Printed Circuit Board Assembly (PCBA) Replacement Procedure

6.3.1 Board Removal and Installation

- 6.3.1.1 To remove the PCBA, the POD needs to be removed from the unit. Remove the POD Assembly by following guidance from section 6.2 “Removal and installation of the Pod Assembly”. Once the POD is removed, replace the board as described in the following steps.



CAUTION:

When handling the printed circuit board assembly, use proper Electro-Static Discharge (ESD) handling precautions.

NOTE:

The PCBA can be replaced in the POD assembly or the Front Panel can be removed from the POD but will require disconnecting the tubing at the check valve.

- 6.3.1.2 Disconnect the large flat ribbon cable connector attaching the Membrane Switch to the PCBA (12 pin connector at J1)
- 6.3.1.3 Disconnect the small electrical connector attached to the Control Valve Assembly (6 pin connector at J6).
- 6.3.1.4 Remove Qty 2 Zip Ties at the Inlet and Outlet of the Flow Tube. When disconnecting the tubing a forward push of the tube onto the barb aids in the loosening the connection. Loosen and remove the tubing from its fitting by gently pulling on the tube and twisting simultaneously. Hold the sensor by its body when twisting and pulling the tubing.



CAUTION:

When pulling the tubing off the oxygen sensor it must be firmly held by its body, to prevent the sensor from detaching from the board. When pulling the tubing from the flow control valve, hold the valve by its body and pull the tubing out.

- 6.3.1.5 Remove Qty 6 small Phillips style screws securing the PCBA to the front panel (save for reinstallation).
- 6.3.1.6 Carefully lift off the Circuit Board (do not slide off due to buzzer and LCD components mounted on the underside of the board) and place into appropriate ESD packaging.

NOTE:

Place the removed board in the Anti-static bag of the replacement board that was received.

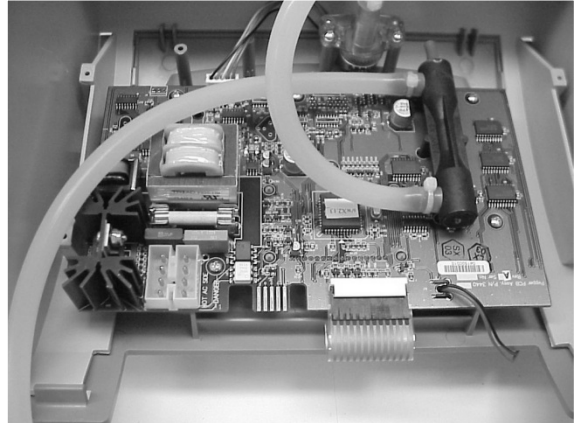

- 6.3.1.7 Installation is the reverse of the removal with the addition of a leak test (see section 6.11.2). Install Zip Ties where the tubing was removed from the fitting barbs.



CAUTION:
Do not over-tighten screws.

20" Silicone Tube,
secured on one end
with Cable Tie

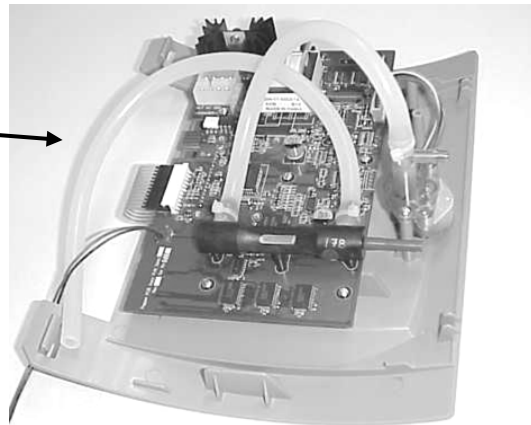
**6.3.2 Leak Test****CAUTION:**

After PCBA installation, a test is required to verify that no leaks were caused during rework! Leaks in the system can cause premature concentrator failure.

6.3.2.1 Required Materials:

A "T" fitting, tubing, pressurized gas source and a gauge will be needed. A pressure gauge Marsh, model J9040, or equivalent with minimum characteristics of 15 psi range, 0.5 psi scale subdivisions, and 4" dial can be used. Bottled air, nitrogen, or oxygen from the outlet of another concentrator can be used to supply the test pressure.

6.3.2.2 Setup and test:

- Step 1) Plug the outlet side of the DISS fitting.
- Step 2) Connect the tube (originally connected to ATF) to oxygen or nitrogen gas at 10 ± 1 psig.
- Step 3) Using a pressure gage with 0-15 psig range, verify the system is pressurize to 10 ± 1 psig.
- Step 4) Once the system is pressurized, shut the supply valve on the pressure source.
- Step 5) Start timing for 60 seconds.
- Step 6) Verify that the pressure did not drop more than 1.8 psig for the 60 second test.

NOTE:

If a leak is found, check the connection, at which tubing was removed and reconnected. Repair of the leak can be done by cutting 1/2" of tubing and reconnecting, so tubing sealing will be re-established. Repeat the test.

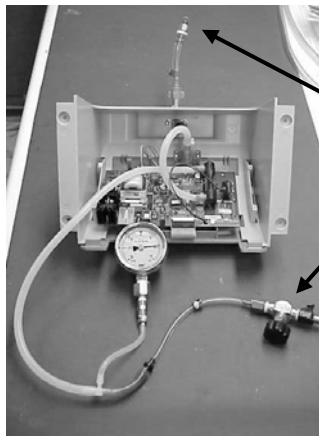

Plug outlet & apply pressure.
Showing the outlet blocked using a cap.

Apply 10psig gas pressure

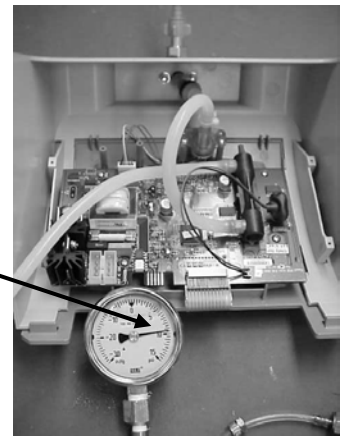

POD Leak test for Integra E-Z

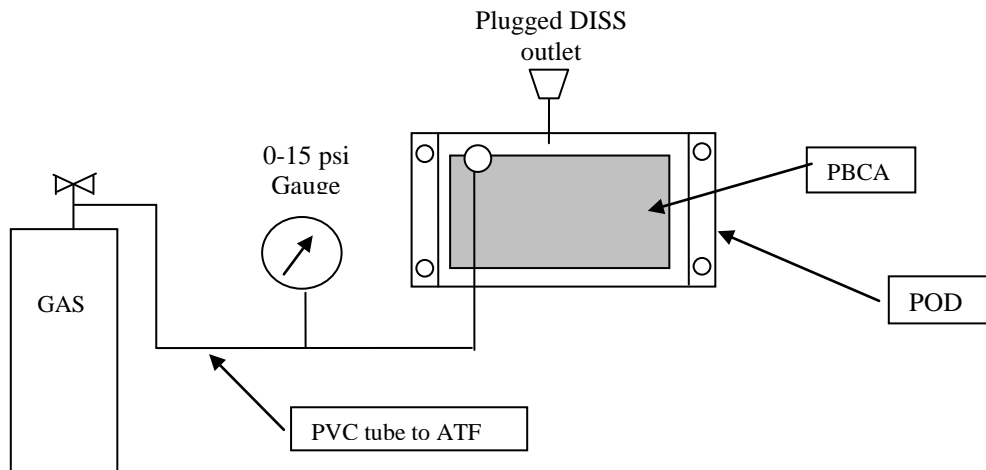

Once the assembly passes the leak test, install the POD following guidance from Section 6.2 “**Removal and Installation of the POD Assembly**”.

6.4 Removal and installation of the ATF module

- 6.4.1 Unplug unit from the AC power source. Confirm that Flow Indicator Backlight is off.
- 6.4.2 Remove the covers.
- 6.4.3 Disconnect the white ATF power connector, shown in the picture, by pressing the locking tabs and pulling the connector housings apart. (see picture on next page)

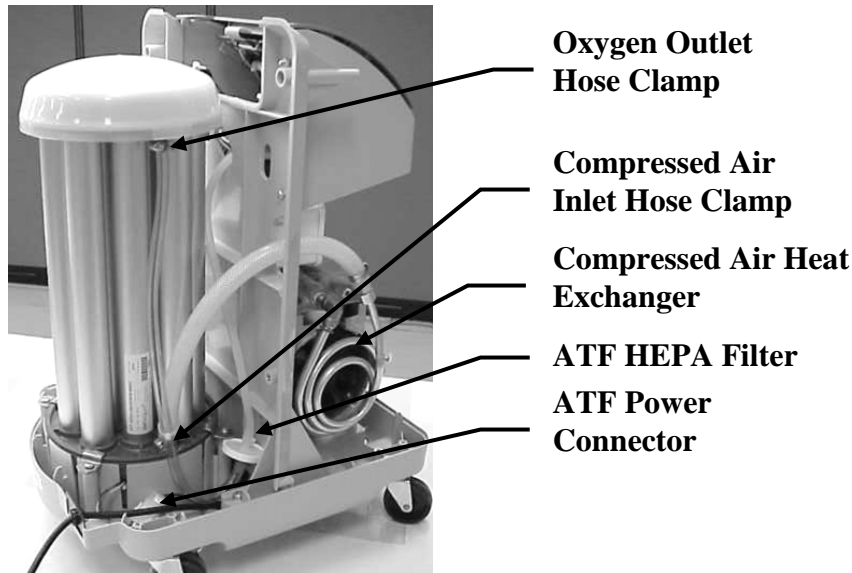

- 6.4.4 Loosen the clamp on the compressed air inlet line and remove the hose. You must Plug or tape over the opening in the ATF.
- 6.4.5 Loosen the clamp on the oxygen outlet tubing and remove the tube. You must Plug or tape over the opening in the ATF.
- 6.4.6 Loosen the four screws holding the clamps to the base. Rotate the clamps to allow the ATF to be pulled upward and clear of the base. There is no need to remove them fully.
- 6.4.7 Installation is the reverse. Ensure that the ATF is properly oriented in the base. Ensure plugs or tape on ATF have been removed. Tighten the toe clamp screws to "20 inch-pounds". Tighten the air supply hose and oxygen tube clamps to "70 inch-ounces".
- 6.4.8 Start the unit and check for leaks.
- 6.4.9 Shut down unit and install covers.

6.5 Removal and installation of the Compressor Assembly

- 6.5.1 Unplug unit from the AC power source. Confirm that Flow Indicator Backlight is off.
- 6.5.2 Remove the covers.
- 6.5.3 Remove the electrical leads to the capacitor.
- 6.5.4 Remove the air supply hose from the filter/muffler assembly by pulling it off the barb fitting on the compressor.
- 6.5.5 Open the lower two wire harness clamps on the center frame by pushing down against the short tab and pulling open the enclosing loop. Disconnect the two-pin connector shown in the illustration.

CAUTION:



Depending upon the date of manufacture, one or more cable ties may attach the compressor leads to the wire harness. Carefully check for these additional cable ties during the remainder of this procedure, Remove as required and replace when assembling back

- 6.5.6 Disconnect the hose from the heat exchanger(using red tubing quick-disconnects).
- 6.5.7 Lay unit on side with the heat exchanger coil facing up. Support the compressor with a foam block or other device. Remove the two compressor bolt inspection covers attached to the base to expose the compressor bolt heads.

6.5.8 Remove the 4 compressor bolts.

NOTE:

The spring mounts will be loose at this point. Use care in hardware removal to avoid loss of parts.

6.5.9 Compressor may now be pulled clear of unit. Check all wire routing while removing to ensure that the compressor wire harness does not snag in other wiring. The compressor wires to the capacitor are routed under the center frame and require care in removal.

6.5.10 If the compressor is being replaced, and new compressor comes without fittings, transfer fittings in compressor head to new compressor. Ensure that fittings are properly oriented as were oriented on the old compressor. Use PermaBond Perma-Lok LH050 or equivalent pipe thread seal. The use of Teflon tape is not recommended. Refer to the picture for proper installation orientation.

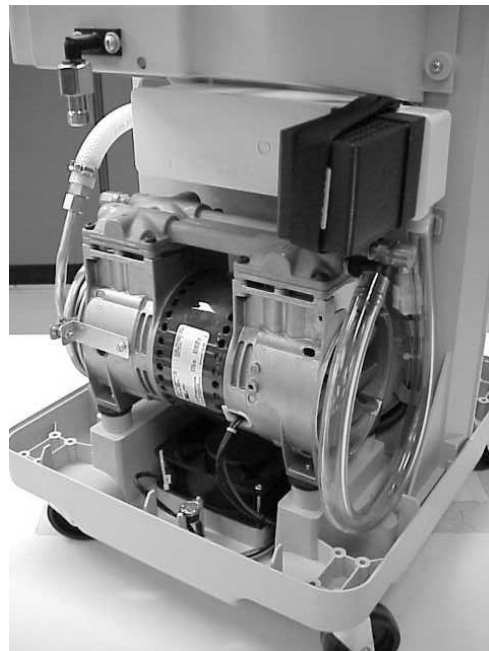
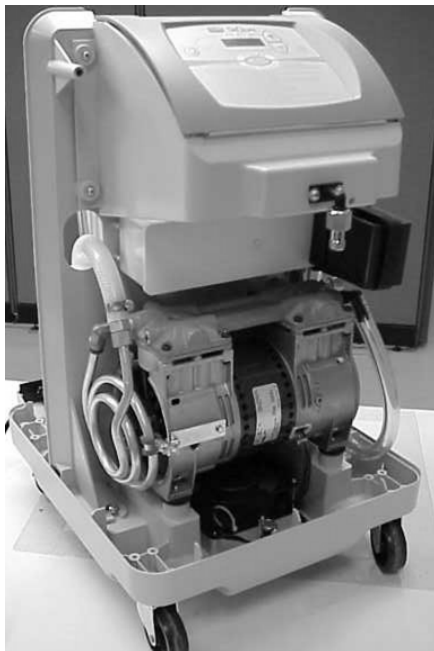

CAUTION:

When installing fittings, do not over-tighten. This can result in damage to the compressor heads. Use tool with 44 in-lbs torque setting for metal fittings, and 2 turns passed finger tight for plastic elbow.



CAUTION:

Prior to installing heat exchanger tubing into push lock fitting ensure that any sharp edges are removed to avoid cutting the O-ring and generating a leak.



6.5.11 Installation is the reverse. Route the compressor capacitor leads under the center frame as the compressor is brought into position. This will make it easier to attach them later. Add Zip Ties where previously removed.

6.5.12 When installing spring mounts, position the rubber step washer between the compressor and the spring and ensure the springs are fully seated in the cup recess on the base.

- 6.5.13 Ensure the rubber washer of the compressor shoulder bolt is positioned between the base and the steel washer. Apply Loctite 271 or equivalent to the threads of the shoulder bolt prior to installation. Torque shoulder bolts to "31 inch-pounds".



CAUTION:

Thread locking compounds may soften plastics. Do not apply excessive thread locker to the bolts. Do not allow the thread locker material to remain in contact with plastic parts if spilled or dropped. Clean any affected area with isopropyl alcohol.



- 6.5.14 Install the compressor bolt inspection covers. Tighten the screws only as required to seat them against the plate.
- 6.5.15 Attach the capacitor leads and reconnect the two-pin power plug. Close the center frame wire harness clamps around the complete harness by pressing the enclosing loop firmly into the seat.

CAUTION:



Carefully inspect the completed wire routing to ensure that the compressor wires do not interfere with the cooling fan operation. Confirm Zip Ties are installed. If the cooling fan is blocked or prevented from turning, the unit will overheat and shut down after approximately fifteen minutes of operation.

- 6.5.16 Re-install the clear air feed tube to the barb on the compressor. Re-attach the hose to the heat exchanger barb fitting and tighten clamp to 70 inch-ounces.
- 6.5.17 Start the unit and check for leaks. If compressor is noisy refer to section 5.7 for troubleshooting.
- 6.5.18 Shut down unit and install covers.

6.6 Compressor Top-End rebuild

NOTE:

Refer to Replacement Parts Section for proper rebuild kit. Contact SeQual Customer Service for all other compressor accessories. Compressor manufacturer instructions supersede SeQual's if differences occur.

NOTE:

Experienced technicians with proper tools may elect to perform the compressor top end rebuild without removing the compressor from the unit. Removing the filter muffler assembly allows adequate clearance for the removal and replacement of the compressor heads. If in doubt, remove the compressor for rebuilding.

- 6.6.1 Unplug unit from the AC power source. Confirm that Flow Indicator Backlight is off.
- 6.6.2 Remove the covers.
- 6.6.3 Remove the clear air inlet tube from the barb (Cap/Cork the tubing to prevent moisture ingress). Disconnect the heat exchanger coil from the fitting on the compressor.
- 6.6.4 For compressor rebuild, follow the service instructions provided with the rebuild kit.



NOTE:

Prior to installing the heat exchanger tubing into push lock fitting ensure that any sharp edges are removed to avoid cutting the O-ring and generating a compressor leak. A compressed air leak will cause the ATF performance to degrade quickly. This will result in premature unit failure.

- 6.6.5 Install the heat exchanger and air inlet hose.
- 6.6.6 If the compressor was removed, re-install according to the compressor removal and installation procedure. (New Spring/Bolt hardware is available upon request)
- 6.6.7 Start the unit and check for leaks. If compressor is noisy refer to section 5.7 for troubleshooting.
- 6.6.8 Shut down unit and install covers.



7. Integra E-Z 5L Specifications

Integra E-Z Model Number 6323A / 6323A-OM Technical Data

Flow Rate	0.5 to 5.0 LPM
Oxygen Concentration	1.0 to 5.0 LPM 91 ± 3% at sea level
Oxygen Concentration Indicator	Green Light = Normal Operation Yellow Light Flashing = Below Normal Operation (85%*) Red Light Flashing = Abnormal Operation (70%**)
Oxygen Outlet Pressure	Nominal 7.5 psig (51.7 kPa) ¹ - Maximum 11.0 psig (75.8 kPa)
Electrical Power	220-240V~, 50Hz, 1.6A Nominal
Operating Temperature	50° F to 104° F (10° C to 40° C)
Sound Level	51.5 dBA Nominal
Dimensions (H x W x D)	26.5 in. (66 cm) H x 14.7in. (37 cm) W x 19.5 in. (50 cm) D
Audible Alarm Indicators	Power Interruption Power Surge (simulated circuit breaker) Compressor Malfunction Excessive Internal Temperature Outlet Pressure [35-36 psig (241.2-248.1 kPa) relief valve] Abnormal Oxygen Flow Rate >±30% target flow Low Therapeutic Oxygen Output** <70% oxygen
Back-up Alarm Power	9V Battery
Filters	Cabinet Air Inlet, Compressor Inlet and HEPA
Device Classification	IEC Class II, Type BF Applied Part, Continuous Operation
Transport/Storage Requirements	Temperature: -4° F (-20° C) to +140° F (+60° C) Humidity: Up to 95% Non-Condensing
Back pressure Effect on Flow Indicator	0 psig (0 kPa): 5.0 LPM 1 psig (7 kPa): 5.0 LPM Nominal
OSCI Operation*	Temperature: 50° F to 104° F (10° C to 40° C) Independent of Atmospheric Pressure.
	85±3% and 70±5% oxygen concentration measurement accuracy

*Where equipped. Subject to ±3% system concentration accuracy, and for backpressures up to 7kPa.
 **Where equipped. Subject to ±5% system concentration accuracy, and for backpressures up to 7kPa.
¹Outlet pressure may decline to 5.0 psig (34.5 kPa) nominal at 10,000 ft altitude.
 System performance may decline above 10,000 ft (3048m).



8. Integra E-Z 7L Specifications

Integra Model Number 6323A-7 / 6323A-OM-7 Technical Data

Flow Rate	0.5 to 7.0 LPM
Oxygen Concentration	0.5 to 7.0 LPM 91 ± 3% at sea level
Oxygen Concentration Indicator	Green Light = Normal Operation Yellow Light Flashing = Below Normal Operation (85%*) Red Light Flashing = Abnormal Operation (70%**)
Oxygen Outlet Pressure	Nominal 7.0 psig (48.2 kPa) ¹ - Maximum 11.0 psig (75.8 kPa)
Electrical Power	115V~, 60Hz, 5.0A Nominal
Operating Temperature	50° F to 104° F (10° C to 40° C)
Sound Level	56.0 dBA Nominal
Dimensions (H x W x D)	26.5 in. (66 cm) H × 14.7in. (37 cm) W × 19.5 in. (50 cm) D
Audible Alarm Indicators	Power Interruption Power Surge (simulated circuit breaker) Compressor Malfunction Excessive Internal Temperature Outlet Pressure [35-36 psig (241.2-248.1 kPa) relief valve] Abnormal Oxygen Flow Rate >±30% target flow Low Therapeutic Oxygen Output** <70% oxygen
Back-up Alarm Power	9V Battery
Filters	Cabinet Air Inlet, Compressor Inlet and HEPA
Device Classification	IEC Class II, Type BF Applied Part, Continuous Operation
Transport/Storage Requirements	Temperature: -4° F (-20° C) to +140° F (+60° C) Humidity: Up to 95% Non-Condensing
Back pressure Effect on Flow Indicator	0 psig (0 kPa): 7.0 LPM 1 psig (7 kPa): 7.0 Nominal LPM
OSCI Operation*	Temperature: 50° F to 104° F (10° C to 40° C) Independent of Atmospheric Pressure.
	85%±3% and 70±5% oxygen concentration measurement accuracy

*Where equipped. Subject to system concentration accuracy, and for backpressures up to 7kPa.

**Where equipped. Subject to ±5% system concentration accuracy, and for backpressures up to 7kPa.

¹Outlet pressure may decline to 5.0 psig (34.5 kPa) nominal at 10,000 ft altitude.

System performance may decline above 10,000 ft (3048m).



9. Integra E-Z 10L Specifications

Integra E-Z Model 6323A-10 / 6323A-OM-10 Technical Data

Flow Rate	0.5 to 10.0 LPM
Oxygen Concentration	1.0 to 10.0 LPM 91 ± 3% at sea level
Oxygen Concentration Indicator	Green Light = Normal Operation Yellow Light Flashing = Below Normal Operation (85%*) Red Light Flashing = Abnormal Operation (70%**)
Oxygen Outlet Pressure	Nominal 6.0 psig (41.4 kPa) ¹ - Maximum 11.0 psig (75.8 kPa)
Electrical Power	115V~, 60Hz, 5.0A Nominal, 220-240V~, 50Hz, 2.2A Nominal
Operating Temperature	50° F to 104° F (10° C to 40° C)
Sound Level	115V units 53.3 dBA Nominal, 230V units 52.3 dBA Nominal
Dimensions (H x W x D)	26.5 in. (66 cm) H x 14.7in. (37 cm) W x 19.5 in. (50 cm) D
Audible Alarm Indicators	Power Interruption Power Surge (simulated circuit breaker) Compressor Malfunction Excessive Internal Temperature Outlet Pressure [35-36 psig (241.2-248.1 kPa) relief valve] Abnormal Oxygen Flow Rate >±30% target flow Low Therapeutic Oxygen Output** <70% oxygen
Back-up Alarm Power	9V Battery
Filters	Cabinet Air Inlet, Compressor Inlet and HEPA
Device Classification	IEC Class II, Type BF Applied Part, Continuous Operation
Transport/Storage Requirements	Temperature: -4° F (-20° C) to +140° F (+60° C) Humidity: Up to 95% Non-Condensing
Back pressure Effect on Flow Indicator	0 psig (0 kPa): 10.0 LPM 1 psig (7 kPa): 10.0 LPM Nominal
OSCI Operation*	Temperature: 50° F to 104° F (10° C to 40° C) Independent of Atmospheric Pressure.
	85±3% and 70±5% oxygen concentration measurement accuracy

*Where equipped. Subject to ±3% system concentration accuracy, and for backpressures up to 7kPa.
 **Where equipped. Subject to ±5% system concentration accuracy, and for backpressures up to 7kPa.
¹Outlet pressure may decline to 5.0 psig (34.5 kPa) nominal at 10,000 ft altitude.
 System performance may decline above 10,000 ft (3048m).



10. Part Numbers

10.1. Preventive Maintenance Parts

Description	SeQual Part Number
Air Inlet Filter	SP2185-SEQ
Compressor Inlet Filter	2607-SEQ
HEPA Filter	SP2033-SEQ
9V Battery	8098-SEQ
Annual PM kit, including filters, 9V battery	4542-SEQ
GAST Compressor Rebuild Kit	3197-SEQ
Thomas Compressor Rebuild Kit	3418-SEQ

10.2. Recommended Spare Parts Inventory(10LPM only)

Description	SeQual Part Number
POD Assembly(OM): SP3486-4-SEQ	Call SeQual Customer Service 1.800.482.2473 option#1 for correct replacement part. Specify Model / SN Number when ordering parts.
Compressor kit Assembly: 3762-SEQ	
ATF Module: 2640V-SEQ	
Printed Circuit Board Assembly - call	
Fuse (F2), 500V 10A, SIBA #189-140 (120V units)	
Fuse (F2), 500V 5A, SIBA # 189-140.5 (220V units)	



Chart SeQual Technologies, Inc.
2200 Airport Industrial Drive, Suite 500
Ball Ground, GA 30107 USA

www.sequal.com

CE0029